

LochAnna

BEAUTY | INNOVATION | QUALITY



LochAnna
kitchens

FORM

EVOKITCHEN
COLLECTION

PRICE LIST AUGUST 2025

Welcome...

...to our new retail price list, which now includes all of our kitchen collections and branded products in one place.

Pages 14 - 65



LochAnna
kitchens

Pages 73 - 97



FORM
BY LOCHANNA

Pages 106 - 111



EVOKITCHEN
COLLECTION
BY LOCHANNA

LochAnna

kitchens

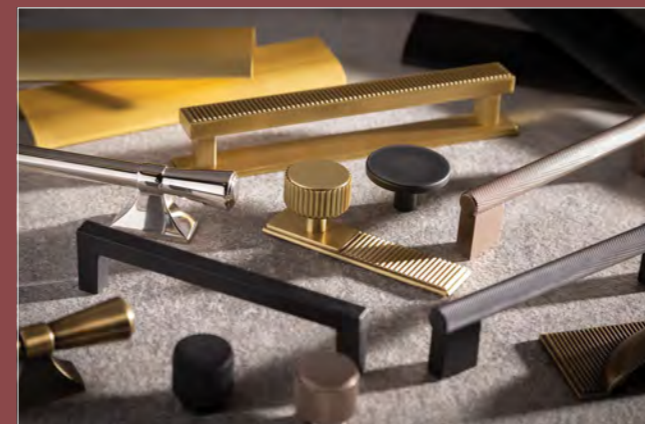

Handles
Page 64 - 72



Solutions Panels and Open Shelving
Page 98

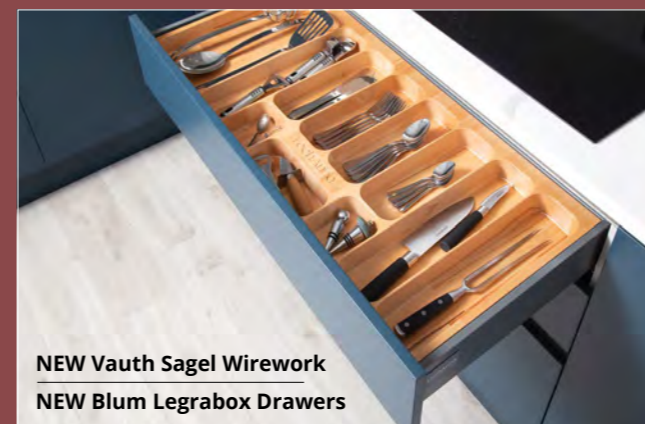

NEW Vauth Sagel Wirework
NEW Blum Legrabox Drawers

Storage and Accessories
Page 99 - 105



VEW Lighting
Page 112 - 115

LochAnna Technical | LochAnna Handmade Technical | Durham Technical | FORM Technical - Page 112 - 115
• Larder & appliance housing configurations • End Elevations

Corner Unit Planning - Page 119

Door Care & Maintenance - Page 120 - 121

LochAnna Door Selector

All of our kitchens are carefully selected by drawing on our extensive experience of European kitchen fashions, married with British classic styles and quality. With 482 different on-trend choices, you can be sure of finding something that will transform your home and enhance your life for years to come.



Eterna Collection*

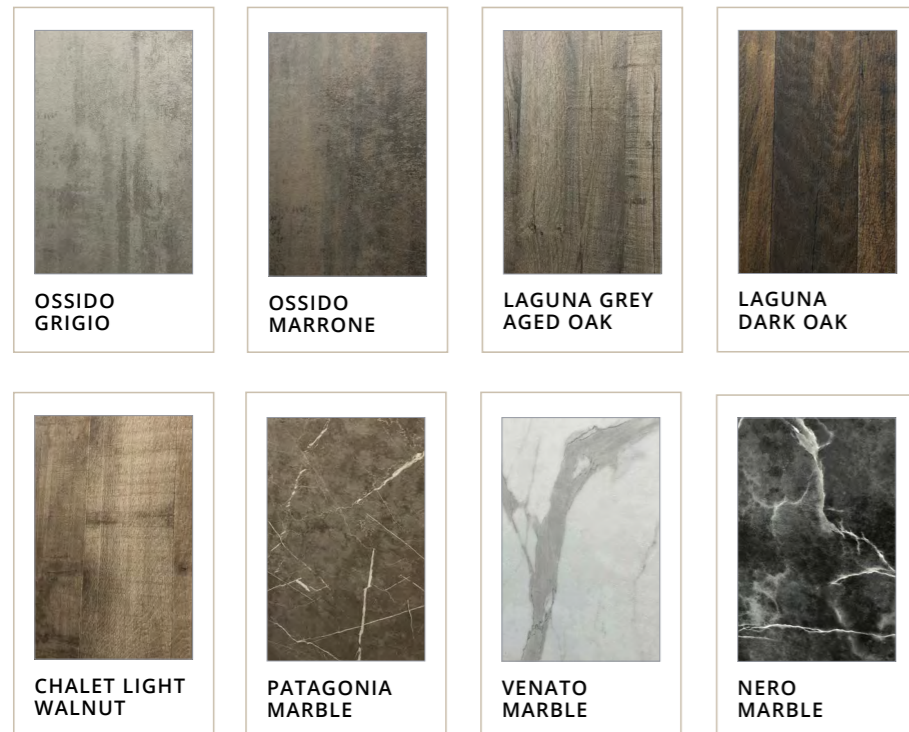

Made to Measure
SERVICE

* To help you create a bespoke finish, Made to Measure doors are available in this range.

Euro Matt Collection*



Profile Gloss Collection



Mala Gloss Collection



Mala Matt Collection



We have six cabinet colours to choose from, simply state on your order which you would prefer.



See pages 10-11 for the cabinet colour supplied as standard on each door colour.

Ainsdale Collection*

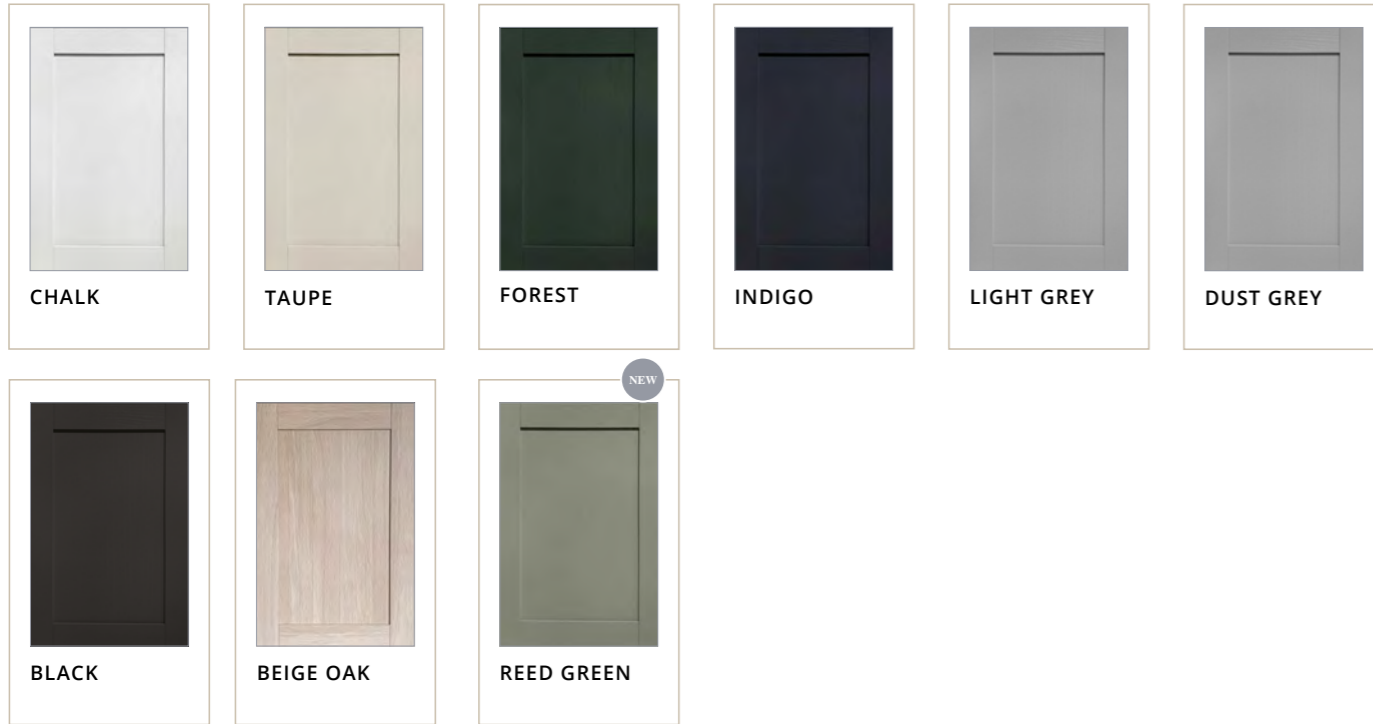

Kirkham Collection*

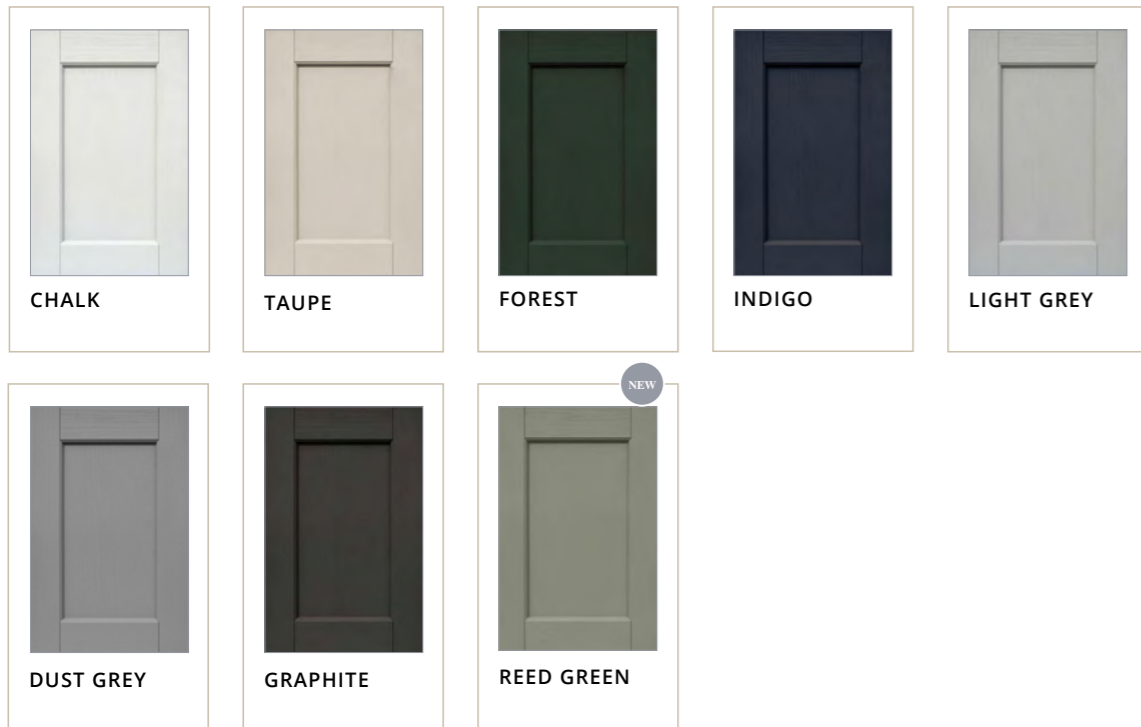

Brompton Collection



Grained Collection

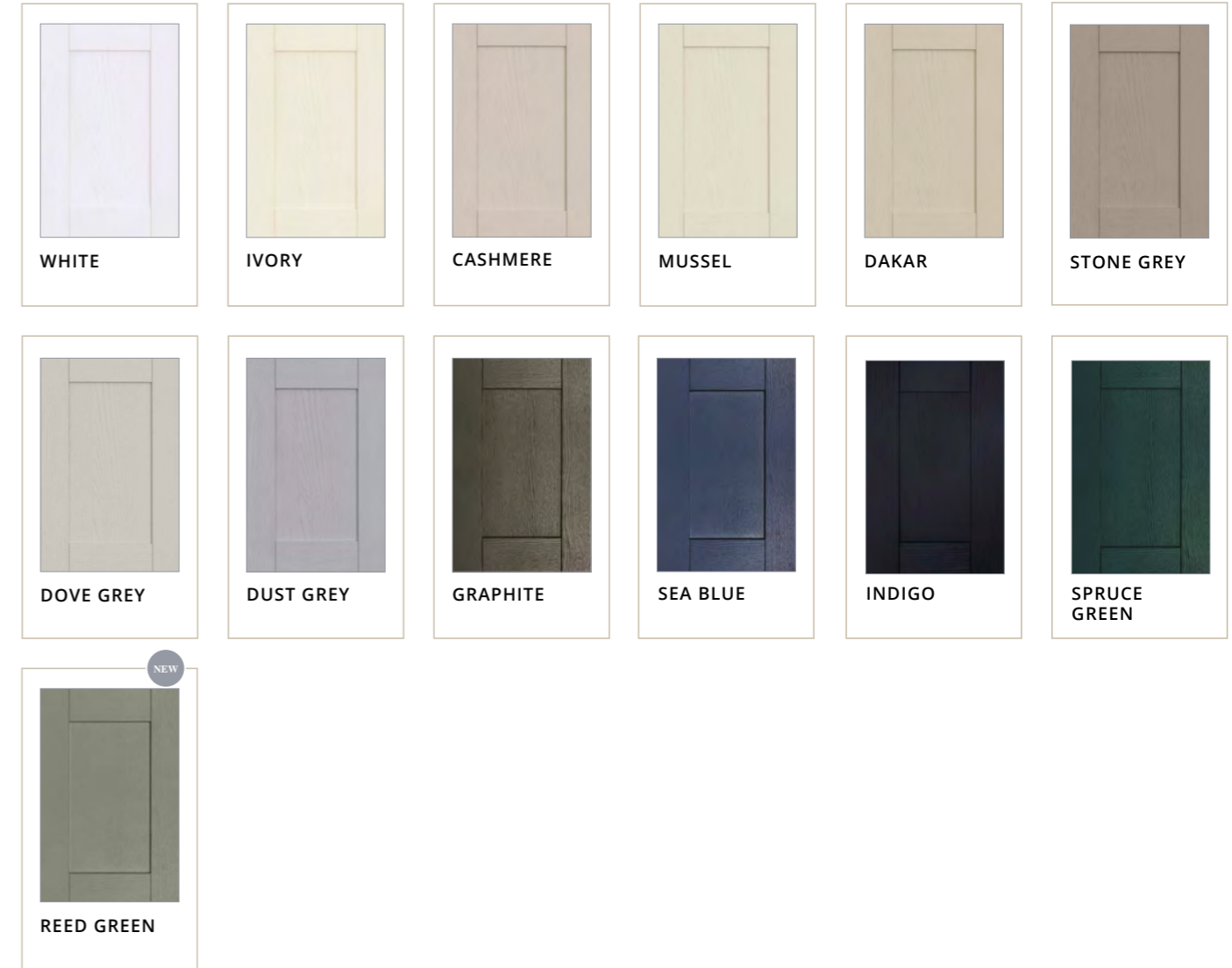

Opaco Collection*

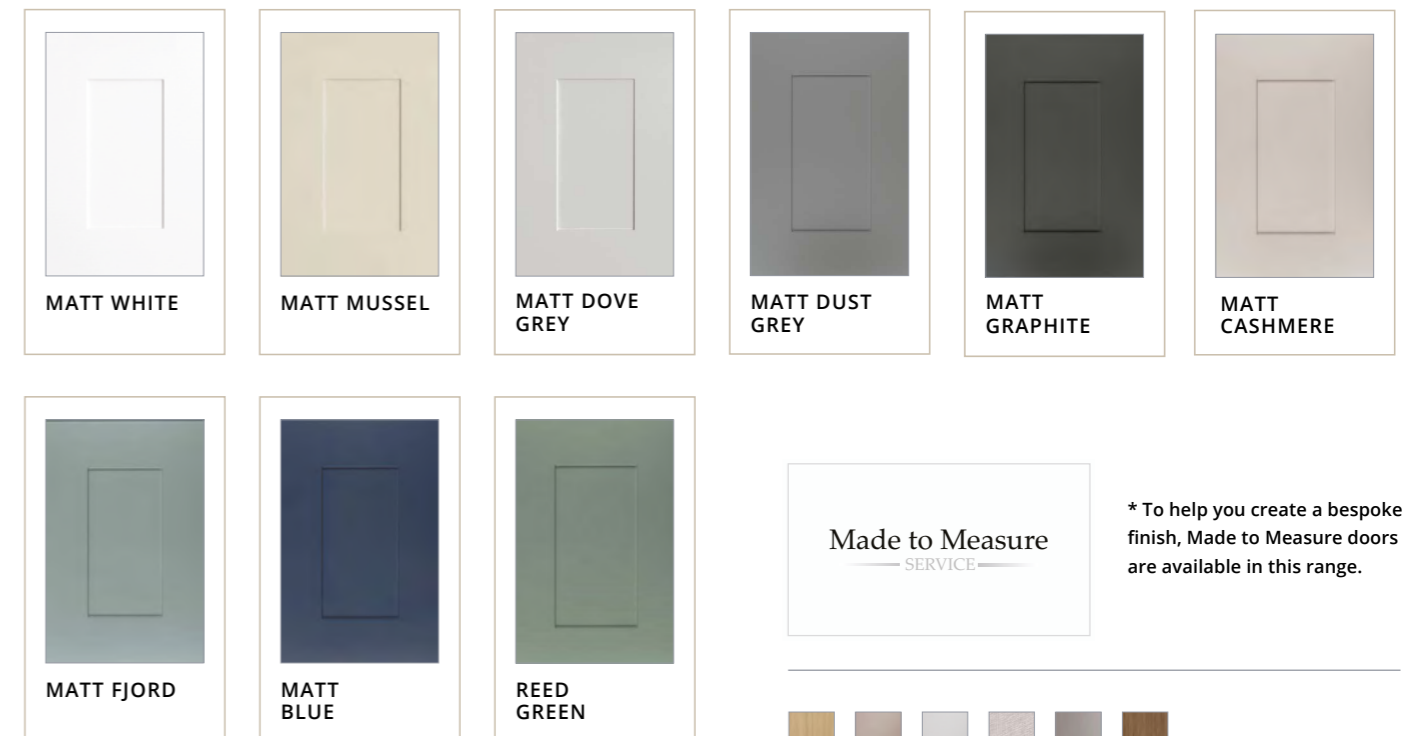

Made to Measure
SERVICE

* To help you create a bespoke finish, Made to Measure doors are available in this range.



We have six cabinet colours to choose from, simply state on your order which you would prefer.

Note: Colours are as accurate as the printing process allows, we recommend that you examine a physical swatch or sample before making your final choice. These can be requested via your retailer.

LochAnna Painted Collections



Durham*

A luxurious solid timber in-frame with beaded detailing on the inner door



Faversham*

A striking and unique solid timber narrow framed shaker door, with an integrated handle



Washington

A velvet smooth painted shaker



Thistleton

A silky smooth painted door with a narrow shaker frame



Georgian*

A solid timber ash painted door with a beaded frame

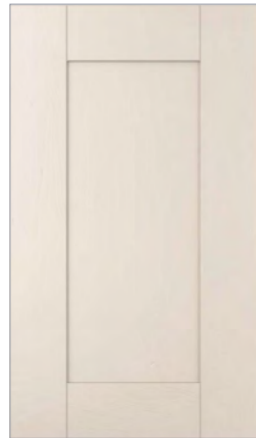

Clarkwell*

A solid timber ash painted shaker



Elswick*

A rich solid timber narrow framed ash shaker door



Profile

A smooth matt painted door with integrated j-handle



Strato*

A classic Italian oak veneered slab door



Hutton*

A solid timber ash inframe effect door with beaded detailing around the frame



Rowan*

A distinctive solid timber ash door with square and concave beading around the frame



Valina*

A beautifully crafted solid timber ash door with an elegant micro shaker frame

Note: As timber doors are made from a natural, living material, some grain and colour variation can be expected within products. Timber is also susceptible to expansion and shrinkage depending on the environment in which it is installed. This potential natural movement of the timber can cause any layer of paint, lacquer, varnish etc. that has been applied to move with it and may result in panel shrinkage and hairline cracks along the joints of the door. All of this is normal and is considered to be a positive feature, adding an authentic look and feel to the kitchen.

Painted colours available



Strato stains available



Colour
MATCHING
Service

Have your kitchen painted in the colour you've always dreamed of. Simply provide us with a recognised colour reference and we'll do the rest! Ask your LochAnna Studio for further details.

Available in all of our painted collections.

Made to Measure
— SERVICE —

* To help you create a bespoke finish, Made to Measure doors are available in this range.

Price Group	Collection	Door Colour	Cabinet Colour	Complementary			Lead Time	
				Wall Replacement End Panels*	Curved Units Available	900mm Tall Walls		
	Euro	Matt Dove Grey	Stone Grey	Yes	No	No	Stocked	
	Euro	Matt Dust Grey	Anthracite Linen	Yes	No	No	Stocked	
	Euro	Matt Mussel	Stone Grey	Yes	No	No	Stocked	
	Euro	Matt Sea Blue	Anthracite Linen	Yes	No	No	Stocked	
	Euro	Matt Graphite	Anthracite Linen	Yes	No	No	4 Weeks	
1	Opaco	Matt Dove Grey	Stone Grey	Yes	No	No	Stocked	
	Opaco	Matt Dust Grey	Anthracite Linen	Yes	No	No	Stocked	
	Opaco	Matt Fjord	Grey Linen	Yes	No	No	Stocked	
	Opaco	Matt Mussel	Stone Grey	Yes	No	No	Stocked	
	Opaco	Matt Sea Blue	Anthracite Linen	Yes	No	No	Stocked	
	Opaco	Matt White	White	Yes	No	No	4 Weeks	
	Opaco	Matt Cashmere	Stone Grey	Yes	No	No	4 Weeks	
	Opaco	Matt Graphite	Anthracite Linen	Yes	No	No	4 Weeks	
	Opaco	Matt Reed Green	Anthracite Linen	Yes	No	No	4 Weeks	
	2	Brompton	Cashmere	Stone Grey	Yes	No	Yes	Stocked
Brompton		Dove Grey	Grey Linen	Yes	No	Yes	Stocked	
Brompton		Dust Grey	Anthracite Linen	Yes	No	Yes	Stocked	
Brompton		Graphite	Anthracite Linen	No	No	Yes	4 Weeks	
Brompton		Stone	Stone Grey	No	No	Yes	4 Weeks	
Brompton		White	White	No	No	Yes	4 Weeks	
Grained		Cashmere	Stone Grey	Yes	Yes	Yes	Stocked	
Grained		Dove Grey	Stone Grey	Yes	Yes	Yes	Stocked	
Grained		Dust Grey	Stone Grey	Yes	Yes	Yes	Stocked	
Grained		Ivory	Lissa Oak	Yes	Yes	Yes	Stocked	
Grained		Mussel	Stone Grey	Yes	Yes	Yes	Stocked	
Grained		Sea Blue	Anthracite Linen	Yes	Yes	Yes	Stocked	
Grained		Stone Grey	Stone Grey	Yes	Yes	Yes	4 Weeks	
Grained		Dakar	Stone Grey	Yes	Yes	Yes	4 Weeks	
Grained		Graphite	Lissa Oak	Yes	Yes	Yes	4 Weeks	
Grained	Indigo	Anthracite Linen	Yes	Yes	Yes	4 Weeks		
Grained	Spruce Green	Lissa Oak	No	Yes	Yes	4 Weeks		
Grained	Reed Green							
Grained	White	White	Yes	Yes	Yes	4 Weeks		
3a	Ainsdale	Chalk	Grey Linen	No	No	Yes	3 Weeks	
	Ainsdale	Light Grey	Grey Linen	No	No	Yes	3 Weeks	
	Ainsdale	Dust Grey	Anthracite Linen	No	No	Yes	3 Weeks	
	Ainsdale	Forest	Lissa Oak	No	No	Yes	3 Weeks	
	Ainsdale	Indigo	Anthracite Linen	No	No	Yes	3 Weeks	
	Ainsdale	Taupe	Grey Linen	No	No	Yes	3 Weeks	
	Ainsdale	Black	Walnut	No	No	Yes	3 Weeks	
	Ainsdale	Beige Oak	Anthracite Linen	No	No	Yes	3 Weeks	
	Ainsdale	Reed Green						
	Kirkham	Chalk	Grey Linen	No	No	Yes	3 Weeks	
	Kirkham	Light Grey	Grey Linen	No	No	Yes	3 Weeks	
	Kirkham	Dust Grey	Anthracite Linen	No	No	Yes	3 Weeks	
	kirkham	Graphite	Anthracite Linen	No	No	Yes	3 Weeks	
	Kirkham	Forest	Lissa Oak	No	No	Yes	3 Weeks	
	Kirkham	Indigo	Anthracite Linen	No	No	Yes	3 Weeks	
Kirkham	Taupe	Grey Linen	No	No	Yes	3 Weeks		
Kirkham	Reed Green							
3b	Mala	Gloss Cashmere	Stone Grey	Yes	No	Yes	4 Weeks	
	Mala	Gloss Dove Grey	Stone Grey	Yes	No	Yes	4 Weeks	
	Mala	Gloss Dust Grey	Stone Grey	Yes	No	Yes	4 Weeks	
	Mala	Gloss Graphite	Stone Grey	Yes	No	Yes	4 Weeks	
	Mala	Gloss Porcelain	White	No	No	Yes	4 Weeks	
	Mala	Gloss White	White	Yes	No	Yes	4 Weeks	
	Mala	Matt Cashmere	Grey Linen	Yes	No	Yes	4 Weeks	
	Mala	Matt Dove Grey	Grey Linen	Yes	No	Yes	4 Weeks	
	Mala	Matt Dust Grey	Grey Linen	Yes	No	Yes	4 Weeks	
	Mala	Matt Graphite	Grey Linen	No	No	Yes	4 Weeks	
	Mala	Matt Moss Green	Walnut	No	No	Yes	4 Weeks	
	Mala	Matt Navy Blue	Grey Linen	No	No	Yes	4 Weeks	
	Mala	Matt Platinum Grey	Grey Linen	No	No	Yes	4 Weeks	
	Mala	Matt Porcelain	White	Yes	No	Yes	4 Weeks	
	Mala	Taupe Grey	Grey Linen	No	No	Yes	4 Weeks	
	Mala	Matt White	White	Yes	No	Yes	4 Weeks	
	4	Eterna	Ossido Grigio	Anthracite Linen	No	No	Yes	4 Weeks
		Eterna	Ossido Marrone	Anthracite Linen	No	No	Yes	4 Weeks
Eterna		Venato Marble	Anthracite Linen	No	No	Yes	4 Weeks	
Eterna		Patagonia Marble	Anthracite Linen	No	No	Yes	4 Weeks	
Eterna		Nero Marble	Anthracite Linen	No	No	Yes	4 Weeks	
Eterna		Chalet Light Walnut	Anthracite Linen	No	No	Yes	4 Weeks	
Eterna		Laguna Grey Aged Oak	Anthracite Linen	No	No	Yes	4 Weeks	
Eterna		Laguna Dark Oak	Anthracite Linen	No	No	Yes	4 Weeks	

Made to Measure door lead times:
Eterna, Euro Matt, Ainsdale, Kirkham,
Opaco: 5 weeks

Elswick, Georgian, Clarkwell, Faversham,
Rowan, Hutton, Strato, Durham: 8 weeks

Price Group	Collection	Door Colour	Cabinet Colour	Complementary			Lead Time	
				Wall Replacement End Panels*	Curved Units Available	900mm Tall Walls		
	Profile	Gloss Cashmere	Stone Grey	Yes	No	Yes	4 Weeks	
	Profile	Gloss Dove Grey	Stone Grey	Yes	No	Yes	4 Weeks	
	Profile	Gloss White	White	Yes	No	Yes	4 Weeks	
	Profile	Gloss Dust Grey	Stone Grey	Yes	No	Yes	4 Weeks	
	Profile	Gloss Graphite	Stone Grey	Yes	No	Yes	4 Weeks	
	Profile	Gloss Porcelain	White	No	No	Yes	4 Weeks	
5	Profile	Matt Dove Grey	Stone Grey	Yes	No	Yes	4 Weeks	
	Profile	Matt Atlantic	Anthracite Linen	No	No	Yes	4 Weeks	
	Profile	Matt White	White	No	No	Yes	4 Weeks	
	Profile	Matt Cashmere	Grey Linen	No	No	Yes	4 Weeks	
	Profile	Matt Dust Grey	Stone Grey	Yes	No	Yes	4 Weeks	
	Profile	Matt Graphite	Stone Grey	No	No	Yes	4 Weeks	
	Profile	Matt Porcelain	White	Yes	No	Yes	4 Weeks	
	6a	Clarkwell / Georgian	Atlantic	Lissa Oak	No	Yes	Yes	4 Weeks
		Clarkwell / Georgian	Ivory	Lissa Oak	No	Yes	Yes	4 Weeks
		Clarkwell / Georgian	Light Grey	Lissa Oak	No	Yes	Yes	4 Weeks
Clarkwell / Georgian		Porcelian	Lissa Oak	No	Yes	Yes	4 Weeks	
Clarkwell / Georgian		Sage	Lissa Oak	No	Yes	Yes	4 Weeks	
Clarkwell / Georgian		Stone	Lissa Oak	No	Yes	Yes	4 Weeks	
Georgian		Laurel Green	Lissa Oak	No	Yes	Yes	4 Weeks	
Georgian		Mussel	Lissa Oak	No	Yes	Yes	4 Weeks	
Georgian		Taupe	Lissa Oak	No	Yes	Yes	4 Weeks	
Clarkwell/Georgian		All Other Painted Colours	Lissa Oak	No	Yes	Yes	5 Weeks	
Clarkwell/Georgian		Colour Matching Service	Lissa Oak	No	Yes	Yes	8 Weeks	
Elswick		Atlantic	Lissa Oak	No	Yes	Yes	4 Weeks	
Elswick		Graphite	Lissa Oak	No	Yes	Yes	4 Weeks	
Elswick		Heather Green	Lissa Oak	No	Yes	Yes	4 Weeks	
Elswick		Laurel Green	Lissa Oak	No	Yes	Yes	4 Weeks	
6b	Elswick	Light Grey	Lissa Oak	No	Yes	Yes	4 Weeks	
	Elswick	Porcelian	Lissa Oak	No	Yes	Yes	4 Weeks	
	Elswick	Stone	Lissa Oak	No	Yes	Yes	4 Weeks	
	Elswick	Taupe	Lissa Oak	No	Yes	Yes	4 Weeks	
	Elswick/Rowan/Valina	All Other Painted Colours	Lissa Oak	No	Yes	Yes	5 Weeks	
	Elswick/Rowan/Valina	Colour Matching Service	Lissa Oak	No	Yes	Yes	8 Weeks	
	7a	Thistleton	Atlantic	Lissa Oak	No	No	Yes	4 Weeks
		Thistleton	Heather Green	Lissa Oak	No	No	Yes	4 Weeks
		Thistleton	Light Grey	Lissa Oak	No	No	Yes	4 Weeks
		Thistleton	Porcelain	Lissa Oak	No	No	Yes	4 Weeks
Thistleton / Washington		All Other Painted Colours	Lissa Oak	No	Yes†	Yes	5 Weeks	
Thistleton / Washington		Colour Matching Service	Lissa Oak	No	Yes†	Yes	8 Weeks	
Profile Painted		Matt Aegean	Anthracite Linen	No	No	Yes	5 Weeks	
Profile Painted		Matt Auburn	Anthracite Linen	No	No	Yes	5 Weeks	
Profile Painted		Matt Breeze	Grey Linen	No	No	Yes	5 Weeks	
Profile Painted		Matt Brigade	Walnut	No	No	Yes	5 Weeks	
Profile Painted	Matt Damson	Anthracite Linen	No	No	Yes	5 Weeks		
Profile Painted	Matt Desert Pink	Grey Linen	No	No	Yes	5 Weeks		
Profile Painted	Matt Heather Green	Anthracite Linen	No	No	Yes	5 Weeks		
Profile Painted	Matt Indigo	Anthracite Linen	No	No	Yes	5 Weeks		
Profile Painted	Matt Ivory	Grey Linen	No	No	Yes	5 Weeks		
Profile Painted	Matt Laurel Green	Lissa Oak	No	No	Yes	5 Weeks		
Profile Painted	Matt Meadow	Anthracite Linen	No	No	Yes	5 Weeks		
Profile Painted	Matt Midnight	Anthracite Linen	No	No	Yes	5 Weeks		
Profile Painted	Matt Mussel	Grey Linen	No	No	Yes	5 Weeks		
7b	Profile Painted	Matt Olive	Anthracite Linen	No	No	Yes	5 Weeks	
	Profile Painted	Matt Pale Teal	Grey Linen	No	No	Yes	5 Weeks	
	Profile Painted	Matt Pearl	Grey Linen	No	No	Yes	5 Weeks	
	Profile Painted	Matt Pebble Grey	Grey Linen	No	No	Yes	5 Weeks	
	Profile Painted	Matt Sage	Grey Linen	No	No	Yes	5 Weeks	
	Profile Painted	Matt Sapphire	Anthracite Linen	No	No	Yes	5 Weeks	
	Profile Painted	Matt Soft Black	Anthracite Linen	No	No	Yes	5 Weeks	
	Profile Painted	Matt Soot	Anthracite Linen	No	No	Yes	5 Weeks	
	Profile Painted	Matt Steel Grey	Anthracite Linen	No	No	Yes	5 Weeks	
	Profile Painted	Matt Stone	Grey Linen	No	No	Yes	5 Weeks	
	Profile Painted	Matt Taupe	Grey Linen	No	No	Yes	5 Weeks	
	Profile Painted	Matt Thicket	Anthracite Linen	No	No	Yes	5 Weeks	
	Profile Painted	Matt Warm Earth	Anthracite Linen	No	No	Yes	5 Weeks	
	Profile Painted	Colour Matching Service	Chosen Cabinet	No	No	Yes	8 Weeks	
	Faversham	All Painted Colours	Lissa Oak	No	No	Yes	5 Weeks	
7c	Faversham	Colour Matching Service	Lissa Oak	No	No	Yes	8 Weeks	
	Hutton	All Painted Colours	Lissa Oak	No	Yes	Yes	5 Weeks	
7d	Hutton	Colour Matching Service	Lissa Oak	No	No	Yes	8 Weeks	
	Strato	All Painted & Stained Colours	Lissa Oak	No	No	Yes	5 Weeks	
8	Strato	Colour Matching Service	Lissa Oak	No	No	Yes	8 Weeks	
	Durham	All Painted Colours	Lissa Oak	No	Yes	Yes	5 Week	
	Durham	Colour Matching Service	Lissa Oak	No	Yes	Yes	8 Weeks	

*Please note: replacement end panels are complementary to the door colour, but may not be an exact match. We recommend you see a sample prior to ordering.

† Washington only.

range overview

Ordering and Choosing...

With kitchens ranging from our budget-friendly Evo Kitchen Collection right through to LochAnna Handmade, you're spoilt for choice. Our price group pages are designed to be simple and easy to use and have lots of information to guide you through the more technical aspects of your design. For further technical information, see our separate Technical Guide.

Step 1 - The first important step

Choose your door style and colour from one of our beautiful collections.

Step 2 - Our cabinets

Choose your preferred cabinet colour.

Our cabinets, constructed from sturdy 18mm panels, allow you to co-ordinate or contrast to your chosen door style. See pages 10-11 on which cabinet colour comes as standard with your chosen door colour.

Note: FORM true handleless kitchens are available on Grey Linen cabinet only.



LochAnna Excel drawer with 30kg load bearing (standard)



Blum Legrabox Carbon Black drawer with 40kg load bearing capacity (option). Upgrade per drawer £100 standard / £140 pan



LochAnna Solid Oak Dovetail drawer with 40kg load bearing capacity (option). Upgrade per drawer £110 standard / £150 pan

Step 3

Select from our Excel drawers or upgrade to Blum Legrabox in Carbon Black or Solid Oak Dovetail drawers with Blum Movento runners. The upgrade prices are shown in each of the Collections price tables.

Step 4 Add handles, our handle options are on pages 66-72

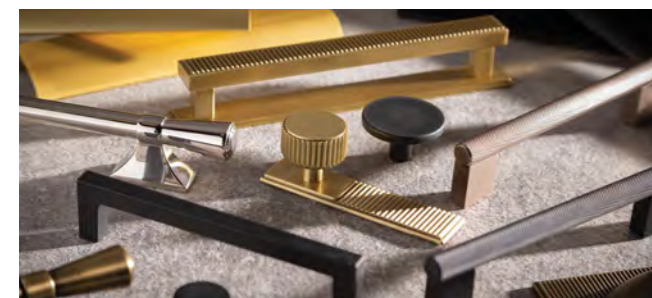

Step 5

Accessories, cutlery trays & inserts, internal drawers plus many more beautiful additions for your kitchen.

See pages 99-105



Step 6 - Don't forget your lighting

VEW Lighting can be ordered along with your kitchen. See pages xxx for details

LochAnna Price Groups

price group	one	euro opaco	page 14-17
price group	two	grained brompton	page 18-21
price group	three ^(a)	ainsdale kirkham	page 22-25
price group	three ^(b)	mala	page 26-29
price group	four	eterna	page 30-33
price group	five	profile	page 34-37
price group	six ^(a)	clarkwell georgian	page 38-41
price group	six ^(b)	elswick rowan valina	page 42-45
price group	seven ^(a)	washington thistleton	page 46-49
price group	seven ^(b)	profile paint to order faversham	page 50-53
price group	seven ^(c)	hutton	page 54-57
price group	seven ^(d)	strato	page 58-61
price group	eight	durham	page 62-65

LochAnna 10 Year Guarantee
All LochAnna Kitchens are manufactured to our stringent materials and workmanship standards. Accordingly, we are pleased to offer our 10 Year guarantee on all LochAnna Kitchens cabinets and door/drawer fascias.

LochAnna
kitchens



Prices include soft close doors and drawers as standard (LochAnna Excel drawers). Handles must be purchased separately.

highline base units																
base unit with VS SUB pull out		single base units								single base units with pull-out waste bin (door is mounted to the bin - see page 117 for full details)						
150mm trays	300mm trays	150mm	300mm	350mm	400mm	450mm	500mm	500mm sink unit (includes base liner)	600mm	600mm sink unit (includes base liner)	300mm + bin (35L-1x35L)	400mm + bin (64L-2x32L)	450mm + bin (70L-2x35L)	500mm + bin (70L-2x35L)	600mm + bin (86L-4xbins)	600mm + bin (80L-2x40L)
BP15TY	BP3TY	BH15	BH30	BH35	BH40	BH45	BH50	BH50S	BH60	BH60S	BH3B	BH4B	BH45B	BH5B	BH6B4	BH6B2
£408	£634	£228	£239	£245	£249	£272	£283	£313	£319	£365	£607	£682	£710	£727	£852	£800

highline base units										highline corner units		
double base units							corner base units 800mm					
700mm	800mm	800mm sink unit (includes base liner)	900mm	900mm sink unit (includes base liner)	1000mm	1000mm sink unit (includes base liner)	300mm door	400mm door	450mm door			
BH70	BH80	BH80S	BH90	BH90S	BH100	BH10S	BC83	BC84	BC84S			
£388	£394	£440	£418	£464	£439	£485	£374	£380	£392			

highline corner units						
corner base unit 900mm	corner base units 1000mm			corner base units 1000mm with VS CORNERSTONE MAXX pull out		corner base units 900mm with VS COR FLEX pull out
450mm door	450mm door	500mm door	600mm door	500mm door	600mm door	450mm door
BC945	BC145	BC15	BC16	BCL15L/R	BCL16L/R	BCO945
£392	£397	£405	£421	£1,270	£1,349	£1,402

highline corner units				feature base units	
corner base units 1000mm with VS COR FLEX pull out			950L corner base unit	belfast sink unit (requires customisation)	
450mm door	500mm door	600mm door	950mm	600mm (495mm high door - for sinks up to 220mm high)	600mm (450mm high door - for sinks up to 265mm high)
BCO145	BCO15	BCO16	BCL9	BSU6495	BSU6450
£1,407	£1,415	£1,431	£618	£285	£283

drawer base units						
Please state which drawer type you would like upon ordering	highline drawer unit with 1 pan drawer & 2 internal drawers					4 drawer unit (1 pan)
	300mm	400mm	500mm	600mm	500mm	
	BHD3	BHD4	BHD5	BHD6	BD54	
Excel	£628	£677	£740	£796	£846	
Legrabox	£968	£1,017	£1,080	£1,136	£1,286	
Oak	£998	£1,047	£1,110	£1,166	£1,326	

drawer base units										
Please state which drawer type you would like upon ordering	3 drawer unit (2 pan)					2 drawer unit (2 pan)		2 drawer unit with internal drawer (2 pan)		low single drawer unit 360mm high
	500mm	600mm	800mm	900mm	1000mm	600mm	900mm	600mm	900mm	600mm
	BD53	BD63	BD83	BD93	BD13	BD62	BD92	BD62I	BD92I	BD635L
Excel	£714	£806	£813	£828	£845	£683	£700	£859	£901	£384
Legrabox	£1,094	£1,186	£1,193	£1,208	£1,225	£963	£980	£1,239	£1,281	£524
Oak	£1,124	£1,216	£1,223	£1,238	£1,255	£983	£1,000	£1,269	£1,311	£534

wall units (720mm high)											
single wall units						double wall units				standard corner units	
300mm	350mm	400mm	450mm	500mm	600mm	700mm	800mm	900mm	1000mm	600mm	900mm
W30	W35	W40	W45	W50	W60	W70	W80	W90	W100	WC6	WC9
£221	£227	£235	£252	£266	£290	£383	£389	£409	£434	£309	£371

wall units (720mm high)			feature wall units					
'L' shaped wall units	bi-fold units		smoked glass wall unit		reeded glass wall unit (glass is clear, not smoked)		microwave wall unit	boiler unit 900mm high
650mm	600mm	900mm	500mm	600mm	500mm	600mm	600mm	600mm door
WCL65	WBI60	WBI90	WGS5	WGS6	WGR5	WGR6	WM60	WBHU
£553	£663	£695	£434	£476	£434	£476	£361	£282

bridging units					
bridging units 285mm high (with Blum Aventos HK-XS)				bridging units 360mm high (with Blum Aventos HK-XS)	
600mm	800mm	900mm	1000mm	600mm	900mm
WB62	WB82	WB92	WB12	WB63	WB93
£237	£295	£312	£338	£295	£344

†† Unit supplied as standard with solid shelves, glass shelves extra. 500mm & 600mm glass shelf (8mm) £70

▲ This unit is made using a 330mm deep cabinet and requires the holes for the legs and drawer runners to be drilled on site.

+ Belfast sink cabinets are the correct height for a 495mm door, if a 450mm door is being used then the cabinet must be trimmed at the bottom. We also recommend you order door coloured material for the sink to sit on with the 495 door unit so that the cabinet is not visible around the edges of the sink.

Prices include soft close doors and drawers as standard (LochAnna Excel drawers). Handles must be purchased separately.

appliance housings - Note: see page 136 for full housing door configurations													
50/50 fridge freezer housing	70/30 fridge freezer housing		double oven housing	double oven housing 2 drawer	double oven / micro housing 1 drawer	single oven housing	single oven housing 1 drawer	single oven housing 2 drawer	single oven housing 3 drawer	single oven / micro housing	single oven / micro housing 2 drawers	twin single oven housing	compact oven / microwave housing
600mm	600mm	If ordering a housing with drawer, please state which drawer type you would like	600mm	600mm	600mm	600mm	600mm	600mm	600mm	600mm	600mm	600mm	600mm
AH-F55	AH-F73		AH-DO	AH-DO2D	AH-DMW	AH-SO	AH-SO1D	AH-SO2D	AH-SO3D	AH-SMW	AH-SM2D	AH-SOT	AH-CO
£735	£711	Excel	£731	£1,058	£927	£750	£896	£1,112	£1,261	£786	£1,074	£876	£823
		Legrabox		£1,338	£1,067		£996	£1,392	£1,641		£1,314	£1,016	
		Oak		£1,358	£1,077		£1,006	£1,412	£1,671		£1,334	£1,026	

built under housings		over counter corner housings			larders			
600 built under oven housing (drawer cannot be upgraded)		If ordering a housing with drawer, please state which drawer type you would like	single oven housing	compact appliance / microwave housing	larder unit 2 door			
fixed panel	with drawer		600mm	600mm	300mm	500mm	600mm	
BOH6	BOHD6	Excel	CH-SO	CH-MW	CH-ST	L3	L5	L6
£199	£312	Legrabox	£654	£700	£880	£663	£723	£794
		Oak		£800	£980			
				£810	£990			

larders									
larder unit with VS TAL Larder pull out	larder drawer tower with excel plus glass drawers (supplied with 155° hinges) Note: this requires the 1245mm door to be fitted at the bottom			larder unit with VS TAL Gate Pro pull out		larder unit with VS TAL Gate pull out		diagonal corner larder 1016 x 1016mm	
300mm	300mm	500mm	600mm	500mm	600mm	500mm	600mm	600mm	
LP3	LT3	LT5	LT6	LP5T	LP6T	LP5TS	LP6TS	LAC	
£1,445	£1,764	£1,892	£2,029	£1,915	£1,980	£1,657	£1,781	£2,084	

larders							
If ordering a larder with drawer, please state which drawer type you would like	larder unit 4 doors	larder unit 2 doors 3 drawers	larder unit 2 doors 2 drawers	1000mm blind corner larder*		1000mm blind corner larder with VS CORNERSTONE MAXX pull out LH / RH (LH Shown)	
	1000mm	1000mm	1000mm	500mm door	600mm door	500mm door	600mm door
	LPN14D	LPN12D3DW	LPN12D2DW	LBC15	LBC16	LBCLM15L/R	LBCLM16L/R
Excel		£1,523	£1,392	£944	£970	£2,782	£2,934
Legrabox	£1,124	£1,903	£1,672				
Oak		£1,933	£1,692				

lifestyle larders						
Our lifestyle larders can be customised, with different colour inner shelves & dividers and outer cabinets. They come automatically with both in the cabinet colour for the range chosen, simply indicate on your order what combination you'd like.	easy access larder	cleaning & utility larder	cleaning & utility larder	cleaning & utility larder - extra shelves	combi larder (this unit comes as standard with full height space in the centre, storage cubes can be added as optional extra)	laundry stacker larder
	600mm	600mm	1000mm	1000mm	1000mm	800mm
	LL6EA	LL6CU	LL10CU	LL10CUS	LL10CB	LL8LS
	£836	£786	£1,235	£1,334	£1,245	£1,364

*If installing alongside base units you must order a tall plant on panel. See page 141 for technical information.

integrated appliance fascias					plain panels					
integrated extractor door	built under fridge / dw / washer door	integrated dishwasher door	semi integrated dishwasher door	boiler door	complementary wall replacement panel	wall plant on panel	wall tall plant on panel	end support panel	large universal panel / breakfast bar back panel	tall plant on panel
450 x 600mm	715 x 600mm	715 x 450mm	570 x 600mm	895 x 600mm	720 x 330mm	720 x 360mm	2000 x 360mm	900 x 600mm	2400 x 900mm	2400 x 630mm
AD60ICH	AD60FD	AD45I	AD60S	BLD9	WREP72	PWEP72	PWEP20	ESP	LUP	PTEP
£95	£131	£107	£129	£133	£77	£92	£200	£135	£391	£305

accessories/trims						
plinth	universal cornice / pelmet	traditional cornice	curved end post	curved end post modern cornice cap	curved end post traditional cornice cap	edging tape roll
2400 x 150mm	3050 x 30 x 50mm	3050 x 63 x 77mm	3050 x 80 x 80mm			10m
PL	BLPEL	SCCRN	CVP	CPBM	CPBC	ET
£90	£86	£113	£123	£109	£116	£37

drawer upgrade options

Price of drawers includes LochAnna Excel soft close drawer boxes. Upgrade prices shown below:



LochAnna Excel drawer (standard)



Blum Legrabox Carbon Black drawer with 40kg load bearing capacity (option). Upgrade per drawer £100 standard / £140 pan



LochAnna Oak Dovetail drawer (option). Upgrade: Standard - £110 Pan - £150

See pages 10-11 for cabinet colour supplied as standard. Please specify cabinet colour when ordering.

Handle options - see pages 80-86. See page 10-11 for lead times.

Prices include soft close doors and drawers as standard (LochAnna Excel drawers). Handles must be purchased separately.

highline base units																
base unit with VS SUB pull out		single base units								single base units with pull-out waste bin (door is mounted to the bin - see page 117 for full details)						
150mm trays	300mm trays	150mm	300mm	350mm	400mm	450mm	500mm	500mm sink unit (includes base liner)	600mm	600mm sink unit (includes base liner)	300mm + bin (35L-1x35L)	400mm + bin (64L-2x32L)	450mm + bin (70L-2x35L)	500mm + bin (70L-2x35L)	600mm + bin (86L-4xbins)	600mm + bin (80L-2x40L)
BP15TY	BP3TY	BH15	BH30	BH35	BH40	BH45	BH50	BH50S	BH60	BH60S	BH3B	BH4B	BH45B	BH5B	BH6B4	BH6B2
£410	£635	£230	£240	£247	£250	£273	£284	£314	£320	£366	£608	£683	£711	£728	£853	£801

highline base units							highline corner units			
double base units							corner base units 800mm			
700mm	800mm	800mm sink unit (includes base liner)	900mm	900mm sink unit (includes base liner)	1000mm	1000mm sink unit (includes base liner)	300mm door	400mm door	450mm door	
BH70	BH80	BH80S	BH90	BH90S	BH100	BH10S	BC83	BC84	BC84S	
£392	£396	£442	£420	£466	£441	£487	£375	£381	£393	

highline corner units						
corner base unit 900mm	corner base unit 1000mm			corner base units 1000mm with VS CORNERSTONE MAXX pull out		corner base units 900mm with VS COR FLEX pull out
450mm door	450mm door	500mm door	600mm door	500mm door	600mm door	450mm door
				Handed by the wirework LH/RH (RH shown) soft close as standard		
BC94S	BC14S	BC15	BC16	BCL15L/R	BCL16L/R	BC094S
£393	£398	£406	£422	£1,271	£1,350	£1,403

highline corner units				feature base units		
corner base units 1000mm with VS COR pull out			950L corner base unit	curved end base unit (grained only)	belfast sink unit (requires customisation)	
450mm door	500mm door	600mm door	950mm	320mm	600mm (495mm high door - for sinks up to 220mm high)	600mm (450mm high door - for sinks up to 265mm high)
BC014S	BC015	BC016	BCL9	BHCV	BSU649S	BSU6450
£1,408	£1,416	£1,432	£622	£625	£284	£284

drawerline base units											
Please state which drawer type you would like upon ordering	single base units				double base units		highline drawer unit with 1 pan drawer & 2 internal drawers				
	300mm	400mm	500mm	600mm	800mm	1000mm	300mm	400mm	500mm	600mm	
	BDL3	BDL4	BDL5	BDL6	BDL8	BDL10	BHD3	BHD4	BHD5	BHD6	
Excel	£415	£438	£473	£476	£772	£819	£629	£678	£741	£797	
Legrabox	£515	£538	£573	£576	£972	£1,019	£969	£1,018	£1,081	£1,137	
Oak	£525	£548	£583	£586	£992	£1,039	£999	£1,048	£1,111	£1,167	

Please state which drawer type you would like upon ordering	drawerline base units			drawerline corner units				
	double base units (1 drawer + 2 door)			corner base unit 800mm			corner base units 1000mm	
	800mm	900mm	1000mm	300mm door/drw	400mm door/drw	500mm door/drw	500mm door/drw	600mm door/drw
	BDL81DW	BDL91DW	BDL101DW	BDLC83	BDLC84	BDLC85	BDLC15	BDLC16
Excel	£654	£679	£712	£550	£569	£590	£595	£578
Legrabox	£754	£779	£812	£650	£669	£690	£695	£678
Oak	£764	£789	£822	£660	£679	£700	£705	£688

Please state which drawer type you would like upon ordering	drawer base units										
	4 drawer unit (1 pan)	3 drawer unit (2 pan)					2 drawer unit (2 pan)		2 drawer unit with internal drawer (2 pan)		low single drawer unit 360mm high
	500mm	500mm	600mm	800mm	900mm	1000mm	600mm	900mm	600mm	900mm	600mm
	BD54	BD53	BD63	BD83	BD93	BD13	BD62	BD92	BD62I	BD92I	BD635L
Excel	£867	£756	£813	£816	£831	£847	£693	£704	£869	£905	£389
Legrabox	£1,307	£1,136	£1,193	£1,196	£1,211	£1,227	£973	£984	£1,249	£1,285	£529
Oak	£1,347	£1,166	£1,223	£1,226	£1,241	£1,257	£993	£1,004	£1,279	£1,315	£539

	wall units (575mm, 720mm & 900mm high)											
	single wall units						double wall units				standard corner units	
	300mm	350mm	400mm	450mm	500mm	600mm	700mm	800mm	900mm	1000mm	600mm	900mm
575mm high	W357		W457	W4557	W557	W657		W857	W957	W157	WC657	WC957
	£249		£263	£278	£292	£281		£445	£461	£486	£396	£421
720mm high	W30	W35	W40	W45	W50	W60	W70	W80	W90	W100	WC6	WC9
	£222	£229	£236	£253	£267	£291	£387	£391	£411	£436	£310	£372
900mm high	TW30		TW40	TW45	TW50	TW60		TW80	TW90	TW100	TWC6	TWC9
	£272		£289	£300	£319	£327		£460	£474	£502	£378	£422

wall units (720mm high)				feature wall units			
'L' shaped wall units	bi-fold units		glass wall unit (oak & walnut cab only)	glass dresser unit (oak & walnut cab only)	curved end wall unit (grained only)	microwave wall unit	boiler unit 900mm high
650mm	600mm	900mm	500mm	500mm	320mm	600mm	600mm door
WCL65	WBI60	WBI90	WG5	WDR50	WCV	WM60	WBHU
£547	£673	£703	£265	£624	£593	£377	£297

bridging units							
bridging units 285mm high (with Blum Aventos HK-XS)				bridging units 360mm high (with Blum Aventos HK-XS)			
600mm	800mm	900mm	1000mm	600mm	800mm	900mm	1000mm
WB62	WB82	WB92	WB12	WB63	WB83	WB93	WB13
£243	£285	£314	£329	£300	£330	£348	£353

†† Unit supplied as standard with solid shelves, glass shelves extra. 500mm & 600mm glass shelf (8mm) £70

** Curved unit filler door to be trimmed on site.

▲ This unit is made using a 330mm deep cabinet and requires the holes for the legs and drawer runners to be drilled on site.

+ Belfast sink cabinets are the correct height for a 495mm door, if a 450mm door is being used then the cabinet must be trimmed at the bottom. We also recommend you order door coloured material for the sink to sit on with the 495 door unit so that the cabinet is not visible around the edges of the sink.

Prices include soft close doors and drawers as standard (LochAnna Excel drawers). Handles must be purchased separately.

appliance housings - Note: see page 136 for full housing door configurations

	50/50 fridge freezer housing	70/30 fridge freezer housing	If ordering a housing with drawer, please state which drawer type you would like	double oven housing	double oven housing 2 drawer	double oven / micro housing 1 drawer	single oven housing	single oven housing 1 drawer
	600mm	600mm		600mm	600mm	600mm	600mm	600mm
	AH-F55	AH-F73		AH-DO	AH-DO2D	AH-DMW	AH-SO	AH-SO1D
Standard height 1968mm	£743	£726	Excel Legrabox Oak	£723	£1,061 £1,341 £1,361	£945 £1,085 £1,095	£751	£899 £999 £1,009
Extra Tall 2148mm	TAH-F55 £788	TAH-F73 £806	Excel Legrabox Oak	TAH-DO £849	TAH-DO2D £1,169 £1,449 £1,469		TAH-SO £854	

	If ordering a housing with drawer, please state which drawer type you would like	single oven housing 2 drawer	single oven housing 3 drawer	single oven / micro housing	single oven / micro housing 2 drawers	twin single oven housing	compact oven / microwave housing
		600mm	600mm	600mm	600mm	600mm	600mm
		AH-SO2D	AH-SO3D	AH-SMW	AH-SM2D	AH-SOT	AH-CO
Standard height 1968mm	Excel Legrabox Oak	£1,120 £1,400 £1,420	£1,273 £1,653 £1,683	£798	£1,090 £1,330 £1,350	£889 £1,029 £1,039	£835
Extra Tall 2148mm	Excel Legrabox Oak	TAH-SO2D £1,228 £1,508 £1,528		TAH-SMW £843		TAH-SOT £716	TAH-CO £849

built under housings	
600 built under oven housing (drawer cannot be upgraded)	
fixed panel	with drawer
BOH6 £209	BOHD6 £322

over counter corner housings			
If ordering a housing with drawer, please state which drawer type you would like	single oven housing	compact appliance / microwave housing	storage unit
	600mm	600mm	600mm
	CH-SO	CH-MW	CH-ST
Excel Legrabox Oak	£656	£705 £805 £815	£897 £997 £1,007
	TCH-SO	TCH-MW	TCH-ST
Excel Legrabox Oak	£858 £958 £968	£794	£945 £1,045 £1,055

larders				
	larder unit 2 door			
	300mm	400mm	500mm	600mm
Standard height 1968mm	L3 £678	L4 £708	L5 £737	L6 £809
Extra Tall 2148mm	TL3 £714	TL4 £745	TL5 £773	TL6 £828

	larder unit with VS TAL Larder pull out	larder drawer tower with excel plus glass drawers (supplied with 155° hinges) Note: this requires the 1245mm door to be fitted at the bottom				larder unit with VS TAL Gate Pro pull out		larder unit with VS TAL Gate pull out		diagonal corner larder 1016 x 1016mm
	300mm	300mm	500mm	600mm	500mm	600mm	500mm	600mm	600mm door	
Standard height 1968mm	LP3 £1,465	LT3 £1,779	LT5 £1,906	LT6 £2,044	LP5T £1,929	LP6T £1,995	LP5TS £1,671	LP6TS £1,796	LAC £2,099	
Extra Tall 2148mm	TLP3 £1,501	TLT3 £1,815	TLT5 £1,942	TLT6 £2,063	TLP5T £1,965	TLP6T £2,014	TLP5TS £1,707	TLP6TS £1,815	TLAC £2,477	

	The extra tall 1000mm larders have an additional top box which needs to be affixed to the top of the standard height unit to make it extra tall. If ordering a larder with drawer, please state which drawer type you would like	1000mm butler's pantry (oak & walnut cab only)	larder unit 4 doors	larder unit 4 doors 1 drawer	larder unit 2 doors 3 drawers	larder unit 2 doors 2 drawers	1000mm blind corner larder*		1000mm blind corner larder with VS CORNERSTONE MAXX pull out LH / RH (LH Shown)	
		1000mm	1000mm	1000mm	1000mm	1000mm	500mm door	600mm door	500mm door	600mm door
		wicker baskets £87 (each) spice racks £662 (pair)							Handed by the wirework LH/RH (LH Shown) soft close as standard	
Standard height 1968mm	Excel Legrabox Oak	LBP10 £2,169 £2,549 £2,982	LPN14D £1,152	LPN14D1DW £1,410 £1,510 £1,520	LPN12D3DW £1,551 £1,931 £1,961	LPN12D2DW £1,414 £1,694 £1,714	LBC15 £958	LBC16 £985	LBCLM15L/R £2,796	LBCLM16L/R £2,949
Extra Tall 2148mm	Excel Legrabox Oak	TLBP10 £2,276 £2,656 £3,089	TLPN14D £1,323				TLBC15 £1,112	TLBC16 £1,122	TLBCLM15L/R £2,950	TLBCLM16L/R £3,086

* If installing alongside base units you must order a tall plant on panel. See page 141 for technical information.

lifestyle larders

Our lifestyle larders can be customised, with different colour inner shelves & dividers and outer cabinets. They come automatically with both in the cabinet colour for the range chosen, simply indicate on your order what combination you'd like. The extra tall larders have an additional top box which needs to be affixed to the top of the standard height unit to make it extra tall.	easy access larder	cleaning & utility larder	cleaning & utility larder	cleaning & utility larder - extra shelves	combi larder (this unit comes as standard with full height space in the centre, storage cubes can be added as optional extra)	laundry stacker larder
	600mm	600mm	1000mm	1000mm	1000mm	800mm
	LL6EA	LL6CU	LL10CU	LL10CUS	LL10CB	LL8LS
Standard height 1968mm	£851	£801	£1,263	£1,362	£1,273	£1,402
Extra Tall 2148mm	TLL6EA £946	TLL6CU £896	TLL10CU £1,434	TLL10CUS £1,533	TLL10CB £1,444	TLL8LS £1,575

integrated appliance fascias					plain panels					
integrated extractor door	built under fridge / dw / washer door	integrated dishwasher door	semi integrated dishwasher door	boiler door	complementary wall replacement panel	wall plant on panel	wall tall plant on panel	end support panel	large universal panel / breakfast bar back panel	tall plant on panel
450 x 600mm	715 x 600mm	715 x 450mm	570 x 600mm	895 x 600mm	720 x 330mm	720 x 360mm	2000 x 360mm	900 x 600mm	2400 x 900mm	2400 x 630mm
AD60ICH	AD60FD	AD45I	AD60S	BLD9	WREP72	PWEP72	PWEP20	ESP	LUP	PTEP
£96	£132	£108	£122	£148	£77	£80	£200	£123	£391	£240

accessories/trims						
open wall unit (oak & walnut cab only)	wine rack (oak & walnut cab only)	working mantle (see separate technical guide for fitting info)	base / wall pilaster	plinth	curved plinth (grained only)	traditional cornice
720 x 500 x 330mm (oak MFC)	720 x 150 x 330mm (oak MFC)	1420 x 1960 x 420mm	960 x 100 x 30mm	2400 x 150mm	400mm	3050 x 63 x 77mm
570OU	WR72	MANTLE	BPIL	PL	CVPL	SCCRN
£188	£200	£1,910	£231	£90	£181	£113

accessories/trims						
traditional curved cornice (grained only)	universal cornice / pelmet	universal curved cornice / pelmet (grained only)	curved end post	curved end post modern cornice cap	curved end post traditional cornice cap	edging tape roll
300mm	3050 x 30 x 50mm	300mm	3050 x 80 x 80mm			10m
CSC	BLPEL	CVBUL	CVP	CPBM	CPBC	ET
£181	£86	£180	£123	£116	£116	£37

drawer upgrade options

Price of drawers includes LochAnna Excel soft close drawer boxes. Upgrade prices shown below:



LochAnna Excel drawer (standard) Blum Legrabox Carbon Black drawer with 40kg load bearing capacity (option). Upgrade per drawer £100 standard / £140 pan LochAnna Oak Dovetail drawer (option) Upgrade: Standard - £110 • Pan - £150

See pages 10-11 for cabinet colour supplied as standard. Please specify cabinet colour when ordering. Handle options - see pages xxxxx. See page 10-11 for lead times.

↑ grain direction
† Working mantle comes with modern cornice and curved end posts. If traditional cornice is required, please state this on your order.
• Total width of the mantle including the curved end posts: 1960mm
• Total depth of the mantle including curved end posts: 420mm
• Total height of the mantle including modern cornice: 1420mm

Prices include soft close doors and drawers as standard (LochAnna Excel drawers). Handles must be purchased separately.

highline base units																
base unit with VS SUB pull out		single base units								single base units with pull-out waste bin (door is mounted to the bin - see page 117 for full details)						
150mm trays	300mm trays	150mm	300mm	350mm	400mm	450mm	500mm	500mm sink unit (includes base liner)	600mm	600mm sink unit (includes base liner)	300mm + bin (35L-1x35L)	400mm + bin (64L-2x32L)	450mm + bin (70L-2x35L)	500mm + bin (70L-2x35L)	600mm + bin (86L-4xbins)	600mm + bin (80L-2x40L)
BP15TY	BP3TY	BH15	BH30	BH35	BH40	BH45	BH50	BH50S	BH60	BH60S	BH3B	BH4B	BH45B	BH5B	BH6B4	BH6B2
£410	£641	£230	£246	£250	£252	£279	£297	£327	£328	£374	£614	£685	£717	£741	£861	£809

highline base units							highline corner units		
double base units							corner base units 800mm		
700mm	800mm	800mm sink unit (includes base liner)	900mm	900mm sink unit (includes base liner)	1000mm	1000mm sink unit (includes base liner)	300mm door	400mm door	450mm door
BH70	BH80	BH80S	BH90	BH90S	BH100	BH10S	BC83	BC84	BC84S
£398	£400	£446	£432	£478	£467	£513	£381	£383	£399

highline corner units						
corner base unit 900mm	corner base units 1000mm			corner base units 1000mm with VS CORNERSTONE MAXX pull out		corner base units 900mm with VS COR FLEX pull out
450mm door	450mm door	500mm door	600mm door	500mm door	600mm door	450mm door
				<p>Handed by the wirework LH/RH (RH shown)</p> <p>soft close as standard</p>		
BC94S	BC14S	BC15	BC16	BCL15L/R	BCL16L/R	BCO94S
£399	£404	£419	£430	£1,284	£1,358	£1,409

highline corner units				feature base units		
corner base units 1000mm with VS COR FLEX pull out			950L corner base unit	belfast sink unit (requires customisation)		
450mm door	500mm door	600mm door	950mm	600mm (495mm high door - for sinks up to 220mm high)	600mm (450mm high door - for sinks up to 265mm high)	800mm (495mm high doors - suits Belfast 200 sink)
BCO14S	BCO15	BCO16	BCL9	BSU649S	BSU6450	BSU849S
£1,414	£1,429	£1,440	£658	£262	£278	£488

drawerline base units											
Please state which drawer type you would like upon ordering	single base units				double base units		highline drawer unit with 1 pan drawer & 2 internal drawers				
	300mm	400mm	500mm	600mm	800mm	1000mm	300mm	400mm	500mm	600mm	
	BDL3	BDL4	BDL5	BDL6	BDL8	BDL10	BHD3	BHD4	BHD5	BHD6	
Excel	£415	£449	£473	£487	£794	£819	£635	£680	£754	£805	
Legrabox	£515	£549	£573	£587	£994	£1,019	£975	£1,020	£1,094	£1,145	
Oak	£525	£559	£583	£597	£1,014	£1,039	£1,005	£1,050	£1,124	£1,175	

drawerline base units				drawerline corner units				
Please state which drawer type you would like upon ordering	double base units (1 drawer + 2 door)			corner base unit 800mm			corner base units 1000mm	
	800mm	900mm	1000mm	300mm door/drw	400mm door/drw	500mm door/drw	500mm door/drw	600mm door/drw
	BDL81DW	BDL91DW	BDL101DW	BDLC83	BDLC84	BDLC85	BDLC15	BDLC16
Excel	£682	£696	£711	£550	£580	£590	£595	£589
Legrabox	£782	£796	£811	£650	£680	£690	£695	£689
Oak	£792	£806	£821	£660	£690	£700	£705	£699

drawer base units											
Please state which drawer type you would like upon ordering	4 drawer unit (1 pan)		3 drawer unit (2 pan)				2 drawer unit (2 pan)		2 drawer unit with internal drawer (2 pan)		low single drawer unit 360mm high
	500mm	500mm	600mm	800mm	900mm	1000mm	600mm	900mm	600mm	900mm	600mm
	BD54	BD53	BD63	BD83	BD93	BD13	BD62	BD92	BD62I	BD92I	BD635L
Excel	£837	£696	£769	£808	£824	£836	£631	£728	£807	£929	£358
Legrabox	£1,277	£1,076	£1,149	£1,188	£1,204	£1,216	£911	£1,008	£1,187	£1,309	£498
Oak	£1,317	£1,106	£1,179	£1,218	£1,234	£1,246	£931	£1,028	£1,217	£1,339	£508

wall units (575mm, 720mm & 900mm high)												
	single wall units						double wall units				standard corner units	
	300mm	350mm	400mm	450mm	500mm	600mm	700mm	800mm	900mm	1000mm	600mm	900mm
575mm high	W357		W457	W4557	W557	W657		W857	W957	W157	WC657	WC957
	£249		£274	£283	£292	£282		£467	£471	£486	£396	£422
720mm high	W30	W35	W40	W45	W50	W60	W70	W80	W90	W100	WC6	WC9
	£228	£232	£238	£259	£280	£299	£393	£395	£423	£462	£343	£407
900mm high	TW30		TW40	TW45	TW50	TW60		TW80	TW90	TW100	TWC6	TWC9
	£279		£291	£309	£329	£312		£464	£492	£522	£416	£438

wall units (720mm high)				feature wall units			
'L' shaped wall units		bi-fold units		glass wall unit (oak & walnut cab only)	glass dresser unit (oak & walnut cab only)	microwave wall unit	boiler unit 900mm high
650mm	600mm	900mm		500mm	500mm	600mm	600mm door
WCL65	WBI60	WBI90		WG5	WDR50	WM60	WBHU
£534	£611	£727		£312	£673	£388	£282

bridging units							
bridging units 285mm high (with Blum Aventos HK-S)				bridging units 360mm high (with Blum Aventos HK-S)			
600mm	800mm	900mm	1000mm	600mm	800mm	900mm	1000mm
WB62	WB82	WB92	WB12	WB63	WB83	WB93	WB13
£265	£317	£338	£357	£297	£333	£378	£390

†† Unit supplied as standard with solid shelves, glass shelves extra. 500mm & 600mm glass shelf (8mm) £70 each

▲ This unit is made using a 330mm deep cabinet and requires the holes for the legs and drawer runners to be drilled on site.

+ Belfast sink cabinets are the correct height for a 495mm door, if a 450mm door is being used then the cabinet must be trimmed at the bottom. We also recommend you order door coloured material for the sink to sit on with the 495 door unit so that the cabinet is not visible around the edges of the sink.

Prices include soft close doors and drawers as standard (LochAnna Excel drawers). Handles must be purchased separately.

appliance housings - Note: see page 136 for full housing door configurations

	50/50 fridge freezer housing	70/30 fridge freezer housing	If ordering a housing with drawer, please state which drawer type you would like	double oven housing	double oven housing 2 drawer	double oven / micro housing 1 drawer	single oven housing	single oven housing 1 drawer
	600mm	600mm		600mm	600mm	600mm	600mm	600mm
	AH-F55	AH-F73		AH-DO	AH-DO2D	AH-DMW	AH-SO	AH-SO1D
Standard height 1968mm	£731	£720	Excel Legrabox Oak	£702	£985 £1,265 £1,285	£929 £1,069 £1,079	£760	£895 £995 £1,005
Extra Tall 2148mm	TAH-F55 £759	TAH-F73 £784	Excel Legrabox Oak	TAH-DO £843	TAH-DO2D £1,078 £1,358 £1,378		TAH-SO £859	

	If ordering a housing with drawer, please state which drawer type you would like	single oven housing 2 drawer	single oven housing 3 drawer	single oven / micro housing	single oven / micro housing 2 drawers	twin single oven housing	compact oven / microwave housing
		600mm	600mm	600mm	600mm	600mm	600mm
		AH-SO2D	AH-SO3D	AH-SMW	AH-SM2D	AH-SOT	AH-CO
Standard height 1968mm	Excel Legrabox Oak	£1,070 £1,350 £1,370	£1,199 £1,579 £1,609	£775	£1,056 £1,296 £1,316	£845 £985 £995	£840
Extra Tall 2148mm	Excel Legrabox Oak	TAH-SO2D £1,163 £1,443 £1,463		TAH-SMW £811		TAH-SOT £688	TAH-CO £826

built under housings	
600 built under oven housing (drawer cannot be upgraded)	
fixed panel	with drawer
BOH6 £198	BOHD6 £311

over counter corner housings			
If ordering a housing with drawer, please state which drawer type you would like	single oven housing	compact appliance / microwave housing	storage unit
	600mm	600mm	600mm
	CH-SO	CH-MW	CH-ST
Excel Legrabox Oak	£644	£703 £803 £813	£890 £990 £1,000
	TCH-SO	TCH-MW	TCH-ST
Excel Legrabox Oak	£835 £935 £945	£757	£930 £1,030 £1,040

	larder unit 2 door				larder unit with VS TAL Larder pull out	
	300mm	400mm	500mm	600mm	300mm	400mm
	L3	L4	L5	L6	LP3	LP4
Standard height 1968mm	£673	£724	£738	£803	£1,460	£1,635
Extra Tall 2148mm	TL3	TL4	TL5	TL6	TLP3	TLP4
	£710	£761	£771	£799	£1,497	£1,672

	larder unit with pull out oak dovetail drawers				larder drawer tower with excel plus glass drawers (supplied with 155° hinges) Note: this requires the 1245mm door to be fitted at the bottom			larder unit with VS TAL Gate Pro pull out		larder unit with VS TAL Gate pull out		diagonal corner larder 1016 x 1016mm
	300mm	400mm	500mm	600mm	300mm	500mm	600mm	500mm	600mm	500mm	600mm	600mm door
	LPOD3	LPOD4	LPOD5	LPOD6	LT3	LT5	LT6	LP5T	LP6T	LP5TS	LP6TS	LAC
Standard 1968mm	£1,753	£1,844	£1,858	£1,928	£1,774	£1,907	£2,038	£1,930	£1,989	£1,672	£1,790	£2,093
Extra Tall 2148mm	TLPOD3	TLPOD4	TLPOD5	TLPOD6	TLT3	TLT5	TLT6	TLP5T	TLP6T	TLP5TS	TLP6TS	TLAC
	£1,790	£1,881	£1,891	£1,924	£1,811	£1,940	£2,034	£1,963	£1,985	£1,705	£1,786	£2,448

	The extra tall 1000mm larders have an additional top box which needs to be affixed to the top of the standard height unit to make it extra tall. If ordering a larder with drawer, please state which drawer type you would like	1000mm butler's pantry (oak & walnut cab only)	larder unit 4 doors	larder unit 4 doors 1 drawer	larder unit 2 doors 3 drawers	larder unit 2 doors 2 drawers	1000mm blind corner larder*	1000mm blind corner larder with VS CORNERSTONE MAXX pull out LH / RH (LH Shown)		
		1000mm	1000mm	1000mm	1000mm	1000mm	500mm door	600mm door	500mm door	600mm door
		wicker baskets £87 (each) spice racks £662 (pair)							Handed by the wirework LH/RH (LH Shown) soft close as standard	
		LBP10	LPN14D	LPN14D1DW	LPN12D3DW	LPN12D2DW	LBC15	LBC16	LBCLM15L/R	LBCLM16L/R
Standard height 1968mm	Excel Legrabox Oak	£2,171 £2,551 £2,984	£1,154	£1,387 £1,487 £1,497	£1,516 £1,896 £1,926	£1,428 £1,708 £1,728	£959	£979	£2,797	£2,943
Extra Tall 2148mm	Excel Legrabox Oak	TLBP10 £2,272 £2,652 £3,085	TLPN14D £1,319				TLBC15	TLBC16	TLBCLM15L/R	TLBCLM16L/R
							£1,110	£1,093	£2,948	£3,057

sd Also available in single door 1965mm (standard height only). Please state on your order if you want the single door unit * If installing alongside base units you must order a tall plant on panel.

lifestyle larders

	easy access larder	cleaning & utility larder	cleaning & utility larder	cleaning & utility larder - extra shelves	combi larder (this unit comes as standard with full height space in the centre, storage cubes can be added as optional extra)	laundry stacker larder
	600mm	600mm	1000mm	1000mm	1000mm	800mm
	LL6EA	LL6CU	LL10CU	LL10CUS	LL10CB	LL8LS
Standard height 1968mm	£845	£795	£1,265	£1,364	£1,275	£1,434
Extra Tall 2148mm	TLL6EA	TLL6CU	TLL10CU	TLL10CUS	TLL10CB	TLL8LS
	£917	£867	£1,430	£1,529	£1,440	£1,607

integrated appliance fascias					plain panels					
integrated extractor door	built under fridge / dw / washer door	integrated dishwasher door	semi integrated dishwasher door	boiler door	wall plant on panel	wall tall plant on panel	end support panel	tall plant on panel	large universal panel / breakfast bar back panel	small breakfast bar back panel
450 x 600mm	715 x 600mm	715 x 450mm	570 x 600mm	895 x 600mm	965 x 360mm	2000 x 360mm	900 x 650mm	2450 x 650mm	910 x 2430mm	900 x 1200mm
AD60ICH	AD60FD	AD45I	AD60S	BLD9	PWEP96	PWEP20	ESP	PTEP	LUP	BBP
£90	£140	£114	£123	£133	£80	£200	£123	£240	£391	£313

T&G panels					accessories / trims		
wall plant on panel	wall tall plant on panel	end support panel	tall plant on panel	breakfast bar back panel	open wall unit (oak & walnut cab only)	wine rack (oak & walnut cab only)	working mantle (see separate technical guide for fitting info)
965 x 360mm	2000 x 360mm	900 x 650mm	2450 x 650mm	900 x 1200mm	720 x 500 x 330mm (oak MFC)	720 x 150 x 330mm (oak MFC)	1400 x 1800 420mm
PWEP96-TG	PWEP20-TG	ESP-TG	PTEP-TG	BBP-TG	57OU	WR72	MANTLE
£93	£230	£142	£277	£360	£188	£200	£2,092

accessories / trims						
shelf bracket	wine rack rail	plinth	skirting plinth	traditional cornice	tangent cornice	universal cornice / pelmet
180 x 37 x 210mm	1200 x 18 x 60mm	3050 x 150 x 18mm	3050 x 150 x 18mm	3050 x 76 x 63mm	3050 x 72 x 44mm	3050 x 50 x 30mm
SHB	WRR	PL	SKPL	SCCRN	TANCOR	BLPEL
£58	£171	£90	£336	£131	£125	£142

accessories / trims						
tangent pelmet	feature end post	curved end post	sculptured curved end post cap	modern curved end post cap	tangent curved end post cap	edging tape roll
3050 x 18 x 57mm	3050 x 50 x 70mm	3050 x 50 x 70mm	84 x 84 x 63mm	220 x 220 x 30mm	88 x 88 x 44mm	10m
TANPEL	FEP	CVP	CPBC	CPBM	CPTA	ET
£98	£180	£183	£116	£116	£116	£37

Prices include soft close doors and drawers as standard (LochAnna Excel drawers). Handles must be purchased separately.

highline base units																
base unit with VS SUB pull out		single base units								single base units with pull-out waste bin (door is mounted to the bin - see page 117 for full details)						
150mm trays	300mm trays	150mm	300mm	350mm	400mm	450mm	500mm	500mm sink unit (includes base liner)	600mm	600mm sink unit (includes base liner)	300mm + bin (35L-1x35L)	400mm + bin (64L-2x32L)	450mm + bin (70L-2x35L)	500mm + bin (70L-2x35L)	600mm + bin (86L-4xbins)	600mm + bin (80L-2x40L)
BP15TY	BP3TY	BH15	BH30	BH35	BH40	BH45	BH50	BH50S	BH60	BH60S	BH3B	BH4B	BH45B	BH5B	BH6B4	BH6B2
£410	£641	£230	£246	£250	£252	£279	£297	£327	£328	£374	£614	£685	£717	£741	£861	£809

highline base units							highline corner units			
double base units						corner base units 800mm			corner base unit 900mm	
700mm	800mm	800mm sink unit (includes base liner)	900mm	900mm sink unit (includes base liner)	1000mm	1000mm sink unit (includes base liner)	300mm door	400mm door	450mm door	450mm door
BH70	BH80	BH80S	BH90	BH90S	BH100	BH10S	BC83	BC84	BC84S	BC94S
£398	£400	£446	£432	£478	£467	£513	£453	£455	£471	£471

highline corner units					
corner base units 1000mm			corner base units 1000mm with VS CORNERSTONE MAXX pull out		corner base units 900mm with VS COR FLEX pull out
450mm door	500mm door	600mm door	500mm door	600mm door	450mm door
BC14S	BC15	BC16	BCL15L/R	BCL16L/R	BCO94S
£476	£491	£502	£1,284	£1,358	£1,409

highline corner units			feature base units		
corner base units 1000mm with VS COR FLEX pull out		950L corner base unit	belfast sink unit (requires customisation)		
450mm door	500mm door	600mm door	950mm	600mm (495mm* high door - for sinks up to 220mm high)	600mm (450mm high door - for sinks up to 265mm high)
BCO14S	BCO15	BCO16	BCL9	BSU649S	BSU6450
£1,414	£1,429	£1,440	£720	£262	£278

drawer base units					
Please state which drawer type you would like upon ordering	highline drawer unit with 1 pan drawer & 2 internal drawers				4 drawer unit (1 pan)
	300mm	400mm	500mm	600mm	500mm
Excel	BHD3	BHD4	BHD5	BHD6	BD54
£635	£680	£754	£805	£837	
Legrabox	£975	£1,020	£1,094	£1,145	£1,277
Oak	£1,005	£1,050	£1,124	£1,175	£1,317

* Please note: Mala Matt Belfast sink unit doors are 490mm high, not 495mm high.

drawer base units														
Please state which drawer type you would like upon ordering	3 drawer unit (2 pan)					2 drawer unit (2 pan)				2 drawer unit with internal drawer (2 pan)				low single drawer unit 360mm high
	500mm	600mm	800mm	900mm	1000mm	600mm	800mm	900mm	1000mm	600mm	800mm	900mm	1000mm	600mm
	BD53	BD63	BD83	BD93	BD13	BD62	BD82	BD92	BD12	BD62I	BD82I	BD92I	BD12I	BD635L
Excel	£696	£769	£808	£824	£836	£631	£646	£728	£748	£807	£839	£929	£954	£358
Legrabox	£1,076	£1,149	£1,188	£1,204	£1,216	£911	£926	£1,008	£1,028	£1,187	£1,219	£1,309	£1,334	£498
Oak	£1,106	£1,179	£1,218	£1,234	£1,246	£931	£946	£1,028	£1,048	£1,217	£1,249	£1,339	£1,364	£508

wall units (575mm, 720mm & 900mm high)												
	single wall units						double wall units				standard corner units	
	300mm	350mm	400mm	450mm	500mm	600mm	700mm	800mm	900mm	1000mm	600mm	900mm
575mm high	W357		W457	W4557	W557	W657		W857	W957	W157	WC657	WC957
	£243		£274	£283	£292	£282		£467	£471	£486	£390	£422
720mm high	W30	W35	W40	W45	W50	W60	W70	W80	W90	W100	WC6	WC9
	£228	£232	£238	£259	£280	£299	£393	£395	£423	£462	£343	£407
900mm high	TW30		TW40	TW45	TW50	TW60		TW80	TW90	TW100	TWC6	TWC9
	£279		£291	£309	£329	£312		£464	£492	£522	£416	£438

wall units (720mm high)						feature wall units	
'L' shaped wall units		bi-fold units				smoked glass wall unit	
650mm	600mm	800mm	900mm	1000mm	500mm	600mm	
WCL65	WBI60	WBI80	WBI90	WBI10	WGS5	WGS6	
£539	£611	£657	£727	£750	£434	£476	

feature wall units			
reeded glass wall unit (glass is clear, not smoked)		microwave wall unit	boiler unit 900mm high
500mm	600mm	600mm	600mm door
WGR5	WGR6	WM60	WBHU
£434	£476	£388	£282

bridging units							
bridging units 285mm high (with Blum Aventos HK-S)				bridging units 360mm high (with Blum Aventos HK-S)			
600mm	800mm	900mm	1000mm	600mm	800mm	900mm	1000mm
WB62	WB82	WB92	WB12	WB63	WB83	WB93	WB13
£265	£317	£338	£357	£297	£333	£378	£390

†† Unit supplied as standard with solid shelves, glass shelves extra. 500mm & 600mm glass shelf (8mm) £70 each

▲ This unit is made using a 330mm deep cabinet and requires the holes for the legs and drawer runners to be drilled on site.

+ Belfast sink cabinets are the correct height for a 495mm door, if a 450mm door is being used then the cabinet must be trimmed at the bottom. We also recommend you order door coloured material for the sink to sit on with the 495 door unit so that the cabinet is not visible around the edges of the sink.

Prices include soft close doors and drawers as standard (LochAnna Excel drawers). Handles must be purchased separately.

appliance housings - Note: see page 136 for full housing door configurations

	50/50 fridge freezer housing	70/30 fridge freezer housing	If ordering a housing with drawer, please state which drawer type you would like	double oven housing	double oven housing 2 drawer	double oven / micro housing 1 drawer	single oven housing	single oven housing 1 drawer
	600mm	600mm		600mm	600mm	600mm	600mm	600mm
	AH-F55	AH-F73		AH-DO	AH-DO2D	AH-DMW	AH-SO	AH-SO1D
Standard height 1968mm	£731	£720	Excel Legrabox Oak	£702	£985 £1,265 £1,285	£929 £1,069 £1,079	£754	£895 £995 £1,005
Extra Tall 2148mm	TAH-F55 £759	TAH-F73 £784	Excel Legrabox Oak	TAH-DO £843	TAH-DO2D £1,078 £1,358 £1,378		TAH-SO £859	

	If ordering a housing with drawer, please state which drawer type you would like	single oven housing 2 drawer	single oven housing 3 drawer	single oven / micro housing	single oven / micro housing 2 drawers	twin single oven housing	compact oven / microwave housing
		600mm	600mm	600mm	600mm	600mm	600mm
		AH-SO2D	AH-SO3D	AH-SMW	AH-SM2D	AH-SOT	AH-CO
Standard height 1968mm	Excel Legrabox Oak	£1,070 £1,350 £1,370	£1,199 £1,579 £1,609	£775	£1,056 £1,296 £1,316	£845 £985 £995	£840
Extra Tall 2148mm	Excel Legrabox Oak	TAH-SO2D £1,163 £1,443 £1,463		TAH-SMW £811		TAH-SOT £688	TAH-CO £826

built under housings	
600 built under oven housing (drawer cannot be upgraded)	
fixed panel	with drawer
BOH6 £198	BOHD6 £311

over counter corner housings			
If ordering a housing with drawer, please state which drawer type you would like	single oven housing	compact appliance / microwave housing	storage unit
	600mm	600mm	600mm
	CH-SO	CH-MW	CH-ST
Excel Legrabox Oak	£644	£703 £803 £813	£890 £990 £1,000
	TCH-SO	TCH-MW	TCH-ST
Excel Legrabox Oak	£835 £935 £945	£757	£930 £1,030 £1,040

	larder unit 2 door				larder unit with VS TAL Larder pull out	
	300mm	400mm	500mm	600mm	300mm	400mm
	L3	L4	L5	L6	LP3	LP4
Standard height 1968mm	£673	£724	£738	£803	£1,460	£1,635
Extra Tall 2148mm	TL3	TL4	TL5	TL6	TLP3	TLP4
	£710	£761	£771	£799	£1,497	£1,672

	larder unit with pull out oak dovetail drawers				larder drawer tower with excel plus glass drawers (supplied with 155° hinges) Note: this requires the 1245mm door to be fitted at the bottom			larder unit with VS TAL Gate Pro pull out		larder unit with VS TAL Gate pull out		diagonal corner larder 1016 x 1016mm
	300mm	400mm	500mm	600mm	300mm	500mm	600mm	500mm	600mm	500mm	600mm	600mm door
	LP0D3	LP0D4	LP0D5	LP0D6	LT3	LT5	LT6	LP5T	LP6T	LP5TS	LP6TS	LAC
Standard 1968mm	£1,753	£1,804	£1,818	£1,883	£1,774	£1,907	£2,038	£1,930	£1,989	£1,672	£1,790	£2,093
Extra Tall 2148mm	TLPOD3	TLPOD4	TLPOD5	TLPOD6	TLT3	TLT5	TLT6	TLP5T	TLP6T	TLP5TS	TLP6TS	TLAC
	£1,790	£1,881	£1,891	£1,924	£1,811	£1,940	£2,034	£1,963	£1,985	£1,705	£1,786	£2,448

	The extra tall 1000mm larders have an additional top box which needs to be affixed to the top of the standard height unit to make it extra tall. If ordering a larder with drawer, please state which drawer type you would like	larder unit 4 doors	larder unit 2 doors 3 drawers	larder unit 2 doors 2 drawers	1000mm blind corner larder*		1000mm blind corner larder with VS CORNERSTONE MAXX pull out LH / RH (LH Shown)	
		1000mm	1000mm	1000mm	500mm door	600mm door	500mm door	600mm door
		LPN14D	LPN12D3DW	LPN12D2DW	LBC15	LBC16	LBCLM15L/R	LBCLM16L/R
Standard height 1968mm	Excel Legrabox Oak	£1,154	£1,516 £1,896 £1,926	£1,428 £1,708 £1,728	£995	£1,015	£2,833	£2,979
Extra Tall 2148mm		TLPN14D £1,319			TLBC15 £1,146	TLBC16 £1,129	TLBCLM15L/R £2,984	TLBCLM16L/R £3,093

SD Also available in single door 1965mm (standard height only). Please state on your order if you want the single door unit. *If installing alongside base units you must order a tall plant on panel. See page 141 for technical information.

lifestyle larders

Our lifestyle larders can be customised, with different colour inner shelves & dividers and outer cabinets. They come automatically with both in the cabinet colour for the range chosen, simply indicate on your order what combination you'd like. The extra tall larders have an additional top box which needs to be affixed to the top of the standard height unit to make it extra tall.	easy access larder	cleaning & utility larder	cleaning & utility larder	cleaning & utility larder - extra shelves	combi larder (this unit comes as standard with full height space in the centre, storage cubes can be added as optional extra)	laundry stacker larder
	600mm	600mm	1000mm	1000mm	1000mm	800mm
	LL6EA	LL6CU	LL10CU	LL10CUS	LL10CB	LL8LS
Standard height 1968mm	£845	£795	£1,265	£1,364	£1,275	£1,434
Extra Tall 2148mm	TLL6EA £917	TLL6CU £867	TLL10CU £1,430	TLL10CUS £1,529	TLL10CB £1,440	TLL8LS £1,607

integrated appliance fascias					plain panels					
integrated extractor door	built under fridge / dw / washer door	integrated dishwasher door	semi integrated dishwasher door	boiler door	complementary wall replacement panel*	wall plant on panel	end support panel	tall plant on panel	large universal panel / breakfast bar back panel	small breakfast bar back panel
450 x 600mm	715 x 600mm	715 x 450mm	570 x 600mm	895 x 600mm	720 x 330mm	960 x 360mm	900 x 650mm	2430 x 650mm	910 x 2430mm	900 x 1200mm
AD60ICH	AD60FD	AD45I	AD60S	BLD9	WREP72	PWEP96	ESP	PTEP2	LUP	BBP
£90	£140	£114	£123	£133	£89	£181	£181	£480	£624	£313

accessories/trims				
plinth	universal cornice / pelmet	feature end post (matt only)	gloss touch up paint	matt touch up paint kit
3000 x 150mm	3000 x 28 x 50mm	3000 x 100 x 50mm	20ml	11ml
PL	SQPEL	FEP	TUP	TUPK
£126	£142	£394	£46	£70

* Mala Gloss Porcelain, Gloss Dove Grey, Gloss Cashmere, Gloss Graphite, Matt Platinum Grey, Matt Indigo Blue, Matt Porcelain and Matt Graphite are plain MFC ends only - plant on panels required

+ Note: the top door on these units in Mala Matt is 490mm high, not 495mm.

▲ Touch up paints and care kits should only be used for minor repairs to backs and edges of doors. They should not be used on door fronts

drawer upgrade options

Price of drawers includes LochAnna Excel soft close drawer boxes. Upgrade prices shown below:



LochAnna Excel drawer (standard)



Blum Legrabox Carbon Black drawer with 40kg load bearing capacity (option). Upgrade per drawer £100 standard / £140 pan



LochAnna Oak Dovetail drawer (option) Upgrade: Standard - £110 • Pan - £150

See pages 10-11 for cabinet colour supplied as standard. Please specify cabinet colour when ordering. Handle options - see pages xxxxx. See page 10-11 for lead times.

Prices include soft close doors and drawers as standard (LochAnna Excel drawers). Handles must be purchased separately.

highline base units																
base unit with VS SUB pull out		single base units									single base units with pull-out waste bin (door is mounted to the bin - see page 117 for full details)					
150mm trays	300mm trays	150mm	300mm	350mm	400mm	450mm	500mm	500mm sink unit (includes base liner)	600mm	600mm sink unit (includes base liner)	300mm + bin (35L-1x35L)	400mm + bin (64L-2x32L)	450mm + bin (70L-2x35L)	500mm + bin (70L-2x35L)	600mm + bin (86L-4xbins)	600mm + bin (80L-2x40L)
BP15TY	BP3TY	BH15	BH30	BH35	BH40	BH45	BH50	BH50S	BH60	BH60S	BH3B	BH4B	BH45B	BH5B	BH6B4	BH6B2
£410	£641	£230	£246	£250	£252	£279	£297	£327	£328	£374	£614	£685	£717	£741	£861	£809

highline base units							highline corner units				
double base units						corner base units 800mm			corner base unit 900mm		
700mm	800mm	800mm sink unit (includes base liner)	900mm	900mm sink unit (includes base liner)	1000mm	1000mm sink unit (includes base liner)	300mm door	400mm door	450mm door	450mm door	
BH70	BH80	BH80S	BH90	BH90S	BH100	BH10S	BC83	BC84	BC84S	BC94S	
£398	£400	£446	£432	£478	£467	£513	£453	£455	£471	£469	

highline corner units					
corner base units 1000mm		corner base units 1000mm with VS CORNERSTONE MAXX pull out		corner base units 900mm with VS COR FLEX pull out	
450mm door	500mm door	600mm door	500mm door	600mm door	450mm door
BC14S	BC15	BC16	BCL15L/R	BCL16L/R	BCO94S
£476	£491	£502	£1,284	£1,358	£1,407

highline corner units			feature base units		
corner base units 1000mm with VS COR FLEX pull out		950L corner base unit	belfast sink unit (requires customisation)		
450mm door	500mm door	600mm door	950mm	600mm (495mm high door - for sinks up to 220mm high)	600mm (450mm high door - for sinks up to 265mm high)
BCO14S	BCO15	BCO16	BCL9	BSU649S	BSU6450
£1,414	£1,429	£1,440	£720	£262	£278

drawer base units					
Please state which drawer type you would like upon ordering	highline drawer unit with 1 pan drawer & 2 internal drawers				4 drawer unit (1 pan)
	300mm	400mm	500mm	600mm	500mm
BHD3	BHD4	BHD5	BHD6	BD54	
Excel	£635	£680	£754	£805	£837
Legrabox	£975	£1,020	£1,094	£1,145	£1,277
Oak	£1,005	£1,050	£1,124	£1,175	£1,317

drawer base units														
Please state which drawer type you would like upon ordering	3 drawer unit (2 pan)					2 drawer unit (2 pan)				2 drawer unit with internal drawer (2 pan)				low single drawer unit 360mm high
	500mm	600mm	800mm	900mm	1000mm	600mm	800mm	900mm	1000mm	600mm	800mm	900mm	1000mm	600mm
BD53	BD63	BD83	BD93	BD13	BD62	BD82	BD92	BD12	BD62I	BD82I	BD92I	BD12I	BD635L	
Excel	£696	£769	£808	£824	£836	£631	£646	£728	£748	£807	£839	£929	£954	£358
Legrabox	£1,076	£1,149	£1,188	£1,204	£1,216	£911	£926	£1,008	£1,028	£1,187	£1,219	£1,309	£1,334	£498
Oak	£1,106	£1,179	£1,218	£1,234	£1,246	£931	£946	£1,028	£1,048	£1,217	£1,249	£1,339	£1,364	£508

wall units (575mm, 720mm & 900mm high)												
	single wall units						double wall units				standard corner units	
	300mm	350mm	400mm	450mm	500mm	600mm	700mm	800mm	900mm	1000mm	600mm	900mm
575mm high	W357		W457	W4557	W557	W657		W857	W957	W157	WC657	WC957
	£243		£274	£283	£292	£282		£467	£471	£486	£390	£422
720mm high	W30	W35	W40	W45	W50	W60	W70	W80	W90	W100	WC6	WC9
	£228	£232	£238	£259	£280	£299	£393	£395	£423	£462	£343	£407
900mm high	TW30		TW40	TW45	TW50	TW60		TW80	TW90	TW100	TWC6	TWC9
	£279		£291	£309	£329	£312		£464	£492	£522	£416	£438

wall units (720mm high)						feature wall units	
'L' shaped wall units		bi-fold units				smoked glass wall unit	
650mm	600mm	800mm	900mm	1000mm	500mm	600mm	
WCL65	WBI60	WBI80	WBI90	WBI10	WGS5	WGS6	
£539	£611	£657	£727	£750	£434	£476	

feature wall units			
reeded glass wall unit (glass is clear, not smoked)		microwave wall unit	boiler unit 900mm high
500mm	600mm	600mm	600mm door
WGR5	WGR6	WM60	WBHU
£434	£476	£388	£282

bridging units							
bridging units 285mm high (with Blum Aventos HK-S)				bridging units 360mm high (with Blum Aventos HK-S)			
600mm	800mm	900mm	1000mm	600mm	800mm	900mm	1000mm
WB62	WB82	WB92	WB12	WB63	WB83	WB93	WB13
£265	£317	£338	£357	£297	£333	£378	£390

†† Unit supplied as standard with solid shelves, glass shelves extra. 500mm & 600mm glass shelf (8mm) £70

▲ This unit is made using a 330mm deep cabinet and requires the holes for the legs and drawer runners to be drilled on site.

+ Belfast sink cabinets are the correct height for a 495mm door, if a 450mm door is being used then the cabinet must be trimmed at the bottom. We also recommend you order door coloured material for the sink to sit on with the 495 door unit so that the cabinet is not visible around the edges of the sink.

Prices include soft close doors and drawers as standard (LochAnna Excel drawers). Handles must be purchased separately.

appliance housings - Note: see page 136 for full housing door configurations								
	50/50 fridge freezer housing	70/30 fridge freezer housing	If ordering a housing with drawer, please state which drawer type you would like	double oven housing	double oven housing 2 drawer	double oven / micro housing 1 drawer	single oven housing	single oven housing 1 drawer
	600mm	600mm		600mm	600mm	600mm	600mm	600mm
	AH-F55	AH-F73		AH-DO	AH-DO2D	AH-DMW	AH-SO	AH-SO1D
Standard height 1968mm	£731	£720	Excel	£702	£985	£929	£754	£895
			Legrabox		£1,265	£1,069		£995
			Oak		£1,285	£1,079		£1,005
Extra Tall 2148mm	£759	£781	Excel	£843	£1,078	£859	£859	£1,005
			Legrabox		£1,358			
			Oak		£1,378			

	If ordering a housing with drawer, please state which drawer type you would like	single oven housing 2 drawer	single oven housing 3 drawer	single oven / micro housing	single oven / micro housing 2 drawers	twin single oven housing	compact oven / microwave housing
		600mm	600mm	600mm	600mm	600mm	600mm
		AH-SO2D	AH-SO3D	AH-SMW	AH-SM2D	AH-SOT	AH-CO
Standard height 1968mm		Excel	£1,070	£1,199	£775	£1,056	£840
		Legrabox	£1,350	£1,579		£1,296	
		Oak	£1,370	£1,609		£1,316	
Extra Tall 2148mm		Excel	£1,163	£811	£811	£995	£826
		Legrabox	£1,443				
		Oak	£1,463				

built under housings		over counter corner housings			larders						
600 built under oven housing (drawer cannot be upgraded)		If ordering a housing with drawer, please state which drawer type you would like	single oven housing	compact appliance / microwave housing	larder unit 2 door				larder unit with VS TAL Larder pull out		
fixed panel	with drawer		600mm	600mm	300mm	400mm	500mm	600mm	300mm	400mm	
	drawer cannot be upgraded										
		Excel	£703	£890	Standard height 1968mm	L3	L4	L5	L6	LP3	LP4
		Legrabox	£803	£990		£673	£724	£738	£803	£1,460	£1,635
		Oak	£813	£1,000		£710	£761	£771	£799	£1,497	£1,672
BOH6	BOHD6	Excel	TCH-SO	TCH-MW	Extra Tall 2148mm †	TL3	TL4	TL5	TL6	TLP3	TLP4
£198	£311	Legrabox	£835	£930		£1,930	£1,989	£1,672	£1,790	£2,093	
		Oak	£935	£1,030		£1,963	£1,985	£1,705	£1,786	£2,448	
			£945	£1,040							

	larder unit with pull out oak dovetail drawers				larder drawer tower with excel plus glass drawers (supplied with 155° hinges) Note: this requires the 1245mm door to be fitted at the bottom			larder unit with VS TAL Gate Pro pull out		larder unit with VS TAL Gate pull out		diagonal corner larder 1016 x 1016mm
	300mm	400mm	500mm	600mm	300mm	500mm	600mm	500mm	600mm	500mm	600mm	600mm door
	LPOD3	LPOD4	LPOD5	LPOD6	LT3	LT5	LT6	LP5T	LP6T	LP5TS	LP6TS	LAC
Standard height 1968mm	£1,753	£1,804	£1,818	£1,883	£1,774	£1,907	£2,038	£1,930	£1,989	£1,672	£1,790	£2,093
	TLPOD3	TLPOD4	TLPOD5	TLPOD6	TLT3	TLT5	TLT6	TLP5T	TLP6T	TLP5TS	TLP6TS	TLAC
Extra Tall 2148mm †	£1,790	£1,881	£1,891	£1,924	£1,811	£1,940	£2,034	£1,963	£1,985	£1,705	£1,786	£2,448

	The extra tall 1000mm larders have an additional top box which needs to be affixed to the top of the standard height unit to make it extra tall. If ordering a larder with drawer, please state which drawer type you would like	larder unit 4 doors	larder unit 2 doors 3 drawers	larder unit 2 doors 2 drawers	1000mm blind corner larder*		1000mm blind corner larder with VS CORNERSTONE MAXX pull out	
		1000mm	1000mm	1000mm	500mm door	600mm door	500mm door	600mm door
		LPN14D	LPN12D3DW	LPN12D2DW	LBC15	LBC16	LBCLM15L/R	LBCLM16L/R
Standard height 1968mm		Excel	£1,516	£1,428	£995	£1,015	£2,833	£2,979
		Legrabox	£1,154	£1,708				
		Oak	£1,926	£1,728				
Extra Tall 2148mm †		TLPN14D			TLBC15	TLBC16	TLBCLM15L/R	TLBCLM16L/R
		£1,319			£1,146	£1,129	£2,984	£3,093

SD Also available in single door 1965mm (standard height only). Please state on your order if you want the single door unit

* If installing alongside base units you must order a tall plant on panel. See page 141 for technical information.

lifestyle larders

	easy access larder	cleaning & utility larder	cleaning & utility larder	cleaning & utility larder - extra shelves	combi larder (this unit comes as standard with full height space in the centre, storage cubes can be added as optional extra)	laundry stacker larder
	600mm	600mm	1000mm	1000mm	1000mm	800mm
	LL6EA	LL6CU	LL10CU	LL10CUS	LL10CB	LL8LS
Standard height 1968mm	£845	£795	£1,265	£1,364	£1,275	£1,434
	TLL6EA	TLL6CU	TLL10CU	TLL10CUS	TLL10CB	TLL8LS
Extra Tall 2148mm †	£917	£867	£1,430	£1,529	£1,440	£1,607

integrated appliance fascias					plain panels				
integrated extractor door	built under fridge / dw / washer door	integrated dishwasher door	semi integrated dishwasher door	boiler door	wall plant on panel	end support panel	tall plant on panel	large universal panel/breakfast bar back panel	small breakfast bar back panel
450 x 600mm	715 x 600mm	715 x 450mm	570 x 600mm	895 x 600mm	960 x 360mm	900 x 650mm	2430 x 650mm	2400 x 900mm	900 x 1200mm
AD60ICH	AD60FD	AD45I	AD60S	BLD9	PWEP96	ESP	PTEP	LUP	BBP
£90	£140	£114	£123	£133	£181	£181	£430	£624	£313

accessories/trims		
plinth	universal cornice / pelmet	edging tape roll
2800 x 150mm	2800 x 18 x 70mm	10m
PL	SQPEL	ET
£126	£66	£37

† Extra tall 2148mm larders are available with either 1245/895mm or 1425/715mm door splits. Please state on your order which you would like

↑ grain direction

Eterna Open Shelving

Made to Measure Open Shelving
You can order made to measure open shelving units in our Eterna finishes. Simply give us the height and width you'd like and we'll make it to your measurements.

- Pricing is calculated using one size down in the matrix. For example, if you need a unit 1255mm high x 350mm wide, you will pay £280 which is the price for a 900x300mm
- Units are 330mm deep, with a 10mm service void
- The price matrix shows how many shelves are supplied with each size
- 300mm wine racks will have two rows of bottle spaces
- Wine racks can be fitted vertically or horizontally

Finishes available

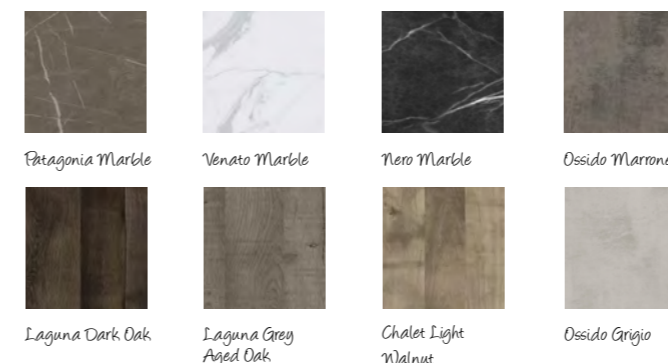

Open Units						
	Height (mm)					
	0	0	0	0	1	
No. of Fixed Shelves	0	0	1	2	3	
No. of Loose Shelves	0	0	1	2	3	
	286	360	720	900	1967	
Width (mm)	150	£228	£228	£254	£280	£648
	300	£228	£228	£254	£280	£648
	400	£252	£252	£268	£292	£662
	500	£254	£254	£287	£312	£707
	600	£274	£274	£305	£338	£771
	700	£330	£330	£369	£401	
	800	£344	£344	£381	£419	
	900	£356	£356	£394	£440	
1000	£369	£369	£407	£444		
1200	£394	£394				

Wine Racks					
	Height (mm)				
	286	720	900	1967	
Width (mm)	150	£254	£344	£381	£762
	300	£330	£496	£585	£1017

Prices include soft close doors and drawers as standard (LochAnna Excel drawers).

highline base units																
base unit with VS SUB pull out		single base units									single base units with pull-out waste bin (door is mounted to the bin - see page 117 for full details)					
150mm trays	300mm trays	150mm	300mm	350mm	400mm	450mm	500mm	500mm sink unit (includes base liner)	600mm	600mm sink unit (includes base liner)	300mm + bin (35L-1x35L)	400mm + bin (64L-2x32L)	450mm + bin (70L-2x35L)	500mm + bin (70L-2x35L)	600mm + bin (86L-4xbins)	600mm + bin (80L-2x40L)
BP15TY	BP3TY	BH15L/R	BH30L/R	BH35L/R	BH40L/R	BH45L/R	BH50L/R	BH50SL/R	BH60L/R	BH60SL/R	BH3B	BH4B	BH45B	BH5B	BH6B4	BH6B2
£433	£684	£253	£289	£294	£300	£321	£328	£358	£358	£404	£657	£733	£759	£772	£891	£839

highline base units							highline corner units			
double base units							corner base units 800mm			corner base unit 900mm
700mm	800mm	800mm sink unit (includes base liner)	900mm	900mm sink unit (includes base liner)	1000mm	1000mm sink unit (includes base liner)	300mm door	400mm door	450mm door	450mm door
BH70	BH80	BH80S	BH90	BH90S	BH100	BH10S	BC83L/R	BC84L/R	BC845L/R	BC945L/R
£486	£496	£542	£516	£562	£529	£575	£511	£518	£528	£528

highline corner units					
corner base units 1000mm			corner base units 1000mm with VS CORNERSTONE MAXX pull out		corner base units 900mm with VS COR FLEX pull out
450mm door	500mm door	600mm door	500mm door	600mm door	450mm door
BC145L/R	BC15L/R	BC16L/R	BCL15L/R	BCL16L/R	BCO945L/R
£533	£537	£547	£1,402	£1,475	£1,538

highline corner units			feature base units			
corner base units 1000mm with VS COR FLEX pull out			950L corner base unit	belfast sink unit (requires customisation)		
450mm door	500mm door	600mm door	950mm	600mm (495mm high door - for sinks up to 220mm high)	600mm (450mm high door - for sinks up to 265mm high)	
BCO145L/R	BCO15L/R	BCO16L/R	BCL9	BSU6495L/R	BSU6450L/R	
£1,543	£1,547	£1,557	£835	£316	£311	

drawer base units						
Please state which drawer type you would like upon ordering	highline drawer unit with 1 pan drawer & 2 internal drawers					4 drawer unit (1 pan)
	300mm	400mm	500mm	600mm	500mm	
	BHD3	BHD4	BHD5	BHD6	BD54	
Excel	£678	£728	£785	£835	£910	
Legrabox	£1,018	£1,068	£1,125	£1,175	£1,350	
Oak	£1,048	£1,098	£1,155	£1,205	£1,390	

drawer base units														
Please state which drawer type you would like upon ordering	3 drawer unit (2 pan)					2 drawer unit (2 pan)				2 drawer unit with internal drawer (2 pan)				low single drawer unit 360mm high
	500mm	600mm	800mm	900mm	1000mm	600mm	800mm	900mm	1000mm	600mm	800mm	900mm	1000mm	600mm
	BD53	BD63	BD83	BD93	BD13	BD62	BD82	BD92	BD12	BD62I	BD82I	BD92I	BD12I	BD635L
Excel	£787	£873	£935	£985	£1,014	£697	£720	£798	£820	£873	£913	£999	£1,026	£391
Legrabox	£1,167	£1,253	£1,315	£1,365	£1,394	£977	£1,000	£1,078	£1,100	£1,253	£1,293	£1,379	£1,406	£531
Oak	£1,197	£1,283	£1,345	£1,395	£1,424	£997	£1,020	£1,098	£1,120	£1,283	£1,323	£1,409	£1,436	£541

wall units (575mm, 720mm & 900mm high)											
	single wall units						double wall units				
	300mm	350mm	400mm	450mm	500mm	600mm	700mm	800mm	900mm	1000mm	
575mm high	W357L/R		W457L/R	W4557L/R	W557L/R	W657L/R		W857	W957	W157	
	£215		£245	£261	£277	£290		£409	£427	£456	
720mm high	W30L/R	W35L/R	W40L/R	W45L/R	W50L/R	W60L/R	W70	W80	W90	W100	
	£271	£276	£286	£301	£311	£329	£481	£491	£507	£524	
900mm high	TW30L/R		TW40L/R	TW45L/R	TW50L/R	TW60L/R		TW80	TW90	TW100	
	£337		£353	£366	£387	£375		£588	£606	£638	

wall units (720mm high)		feature wall units			
'L' shaped wall units		smoked glass wall unit		reeded glass wall unit (glass is clear, not smoked)	
650mm		500mm	600mm	500mm	600mm
WCL65		WGS5	WGS6	WGR5	WGR6
£765		£434	£476	£434	£476

feature wall units	
microwave wall unit	boiler unit 900mm high
600mm	600mm door
WM60	WBHUL/R
£444	£345

bridging units							
bridging units 285mm high (with Blum Aventos HK-S)				bridging units 360mm high (with Blum Aventos HK-S)			
600mm	800mm	900mm	1000mm	600mm	800mm	900mm	1000mm
WB62	WB82	WB92	WB12	WB63	WB83	WB93	WB13
£301	£359	£378	£389	£330	£396	£413	£426

** Standard corner base supplied with fixed J pull 80mm post. To suit 950/1050/1100/1150/1250mm arrangement. If reducing to 930/1030/1080/1130/1230mm use 60mm J-pull post (ask when ordering unit). If corner base is to be outside these dimensions, use a base conversion filler and cut to suit. Supplied in slab only (not J-pull design).

IMPORTANT: Profile doors are handed by the side they hinge to the cabinet and are drilled to order, please specify either L or R at the end of your unit code when ordering. For hinge drilling, all doors are treated as base doors, so if you order a LH hinged wall unit, the code on the door packaging will be RH as the door is rotated upside down so the j pull handle groove is at the bottom.

†† Unit supplied as standard with solid shelves, glass shelves extra. 500mm & 600mm glass shelf (8mm) £70 each

▲ This unit is made using a 330mm deep cabinet and requires the holes for the legs and drawer runners to be drilled on site.

+ Belfast sink cabinets are the correct height for a 495mm door, if a 450mm door is being used then the cabinet must be trimmed at the bottom. We also recommend you order door coloured material for the sink to sit on with the 495 door unit so that the cabinet is not visible around the edges of the sink.

Prices include soft close doors and drawers as standard (LochAnna Excel drawers).

appliance housings - Note: see page 136 for full housing door configurations

	50/50 fridge freezer housing	70/30 fridge freezer housing	If ordering a housing with drawer, please state which drawer type you would like	double oven housing	double oven housing 2 drawer	double oven / micro housing 1 drawer	single oven housing	single oven housing 1 drawer
	600mm	600mm		600mm	600mm	600mm	600mm	600mm
	AH-F55	AH-F73L/R		AH-DOL/R	AH-DO2DL/R	AH-DMW	AH-SOL/R	AH-SO1DL/R
Standard height 1968mm	£863	£837	Excel	£764	£1,133	£1,032	£823	£989
			Legrabox		£1,413	£1,172		£1,089
			Oak		£1,433	£1,182		£1,099
Extra Tall 2148mm	£909	£931	Excel	£966	£1,232		£939	
			Legrabox		£1,512			
			Oak		£1,532			

	If ordering a housing with drawer, please state which drawer type you would like	single oven housing 2 drawer	single oven housing 3 drawer	single oven / micro housing	single oven / micro housing 2 drawers	twin single oven housing	compact oven / microwave housing	
		600mm	600mm	600mm	600mm	600mm	600mm	
		AH-SO2DL/R	AH-SO3DL/R	AH-SMWL/R	AH-SM2DL/R	AH-SOTL/R	AH-COL/R	
Standard height 1968mm	Excel	£1,180	£1,329	£861	£1,166	£954	£920	
		Legrabox	£1,460		£1,709	£1,406		£1,085
		Oak	£1,480		£1,739	£1,426		£1,095
Extra Tall 2148mm	Excel	TAH-SO2DL/R		TAH-SMWL/R		TAH-SOTL/R	TAH-COL/R	
		Legrabox	£1,279			£775		
		Oak	£1,559		£893	£949		

built under housings

600 built under oven housing (drawer cannot be upgraded)	
fixed panel	with drawer
BOH6	BOHD6
£218	£331

over counter corner housings

If ordering a housing with drawer, please state which drawer type you would like	single oven housing	compact appliance / microwave housing	storage unit
	600mm	600mm	600mm
	CH-SOL/R	CH-MWL/R	CH-STL/R
Excel	£777	£936	
	Legrabox	£708	£1086
	Oak	£887	£1096
Excel	TCH-SOL/R	TCH-MWL/R	TCH-STL/R
	Legrabox	£919	£1,047
	Oak	£1,019	£1,147
		£860	£1,157

larders

	larder unit 2 door				larder unit with VS TAL Larder pull out	
	300mm	400mm	500mm	600mm	300mm	400mm
	L3L/R	L4L/R	L5L/R	L6L/R	LP3	LP4
Standard height 1968mm	£778	£810	£840	£920	£1565	£1721
Extra Tall 2148mm †	TL3L/R	TL4L/R	TL5L/R	TL6L/R	TLP3	TLP4
	£830	£861	£900	£949	£1617	£1772

larders

	larder unit with pull out oak dovetail drawers				larder drawer tower with excel plus glass drawers (supplied with 155° hinges) Note: this requires the 1245mm door to be fitted at the bottom			larder unit with VS TAL Gate Pro pull out		larder unit with VS TAL Gate pull out		diagonal corner larder 1016 x 1016mm
	300mm	400mm	500mm	600mm	300mm	500mm	600mm	500mm	600mm	500mm	600mm	600mm door
	LPOD3	LPOD4	LPOD5	LPOD6	LT3L/R	LT5L/R	LT6L/R	LP5TL/R	LP6TL/R	LP5TSL/R	LP6TSL/R	LACL/R
Standard height 1968mm	£1,858	£1,890	£1,920	£2,000	£1,879	£2,009	£2,155	£2,024	£2,106	£1,774	£1,907	£2,210
Extra Tall 2148mm	TLPOD3	TLPOD4	TLPOD5	TLPOD6	TLT3L/R	TLT5L/R	TLT6L/R	TLP5TL/R	TLP6TL/R	TLP5TSL/R	TLP6TSL/R	TLACL/R
	£1,910	£1,981	£2,020	£2,074	£1,931	£2,069	£2,184	£2,096	£2,135	£1,834	£1,936	£2,598

	The extra tall 1000mm larders have an additional top box which needs to be affixed to the top of the standard height unit to make it extra tall. If ordering a larder with drawer, please state which drawer type you would like	larder unit 4 doors	larder unit 2 doors 3 drawers	larder unit 2 doors 2 drawers	1000mm blind corner larder*		1000mm blind corner larder with VS CORNERSTONE MAXX pull out LH / RH (LH Shown)	
		1000mm	1000mm	1000mm	500mm door	600mm door	500mm door	600mm door
		LPN14D	LPN12D3DW	LPN12D2DW	LBC15L/R	LBC16L/R	LBCLM15L/R	LBCLM16L/R
Standard height 1968mm	Excel	£1,358	£1,836	£1,642	£1,097	£1,132	£2,935	£3,096
		Legrabox	£2,216	£1,922				
		Oak	£2,246	£1,942				
Extra Tall 2148mm	Excel	TLPN14D			TLBC15L/R	TLBC16L/R	TLBCLM15L/R	TLBCLM16L/R
		£1,577			£1,275	£1,279	£3,113	£3,243

SD Also available in single door 1965mm (standard height only). Please state on your order if you want the single door unit

* If installing alongside base units you must order a tall plant on panel. See page 141 for technical information.

lifestyle larders

Our lifestyle larders can be customised, with different colour inner shelves & dividers and outer cabinets. They come automatically with both in the cabinet colour for the range chosen, simply indicate on your order what combination you'd like. The extra tall larders have an additional top box which needs to be affixed to the top of the standard height unit to make it extra tall.	easy access larder	cleaning & utility larder	cleaning & utility larder	cleaning & utility larder - extra shelves	combi larder (this unit comes as standard with full height space in the centre, storage cubes can be added as optional extra)	laundry stacker larder
	600mm	600mm	1000mm	1000mm	1000mm	800mm
	LL6EAL/R	LL6CUL/R	LL10CU	LL10CUS	LL10CB	LL8LS
Standard height 1968mm	£962	£912	£1,469	£1,568	£1,479	£1,606
	TLL6EAL/R	TLL6CUL/R	TLL10CU	TLL10CUS	TLL10CB	TLL8LS
Extra Tall 2148mm	£1,067	£1,017	£1,688	£1,787	£1,698	£2,163

optional cubes available in our 6 cabinet colours:
547mm depth - £140
447mm depth - £121

integrated appliance fascias

integrated extractor door	built under fridge / dw / washer door	integrated dishwasher door	semi integrated dishwasher door	boiler door	complementary wall replacement panel* (MFC)	wall plant on panel	end support panel	feature end support panel	tall plant on panel	large universal panel/breakfast bar back panel	small breakfast bar back panel
450 x 600mm	715 x 600mm	715 x 450mm	570 x 600mm	895 x 600mm	720 x 330mm	960 x 360mm	900 x 650mm	900 x 650mm	2430 x 650mm	910 x 2430mm	900 x 1200mm
AD60ICH	AD60FD	AD45I	AD60S	BLD9L/R	WREP72	PWEP96	ESP	BIFP	PTEP2	LUP	BBP
£123	£170	£156	£131	£196	£89	£181	£181	£236	£480	£624	£626

accessories/trims

plinth	universal cornice / pelmet	external corner post	base internal corner post	wall internal corner post	touch up paint
3000 x 150mm	3000 x 28 x 50mm	930 x 70 x 70mm	715 x 80mm	715 x 60mm	20ml
PL	SQPEL	EXCP	LBF	LWF	TUP
£126	£142	£250	£159	£159	£46

* Profile Gloss Porcelain, Gloss Dove Grey, Gloss Cashmere, Gloss Graphite, Matt Atlantic, Matt Porcelain and Matt Graphite are plain MFC ends only - plant on panels required

▲ Touch up paints and care kits should only be used for minor repairs to backs and edges of doors. They should not be used on door fronts

drawer upgrade options

Price of drawers includes LochAnna Excel soft close drawer boxes. Upgrade prices shown below:



LochAnna Excel drawer (standard)



Blum Legrabox Carbon Black drawer with 40kg load bearing capacity (option). Upgrade per drawer £100 standard / £140 pan

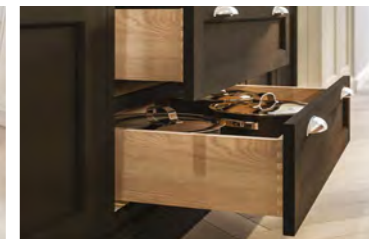

LochAnna Oak Dovetail drawer (option). Upgrade: Standard - £110 Pan - £150

See pages 10-11 for cabinet colour supplied as standard. Please specify cabinet colour when ordering. See page 10-11 for lead times.

IMPORTANT: Profile doors are handed by the side they hinge to the cabinet and are drilled to order, please specify either L or R at the end of your unit code when ordering. For hinge drilling, all doors are treated as base doors, so if you order a LH hinged wall unit, the code on the door packaging will be RH as the door is rotated upside down so the j pull handle groove is at the bottom.

Prices include soft close doors and drawers as standard (LochAnna Excel drawers). Handles must be purchased separately.

highline base units																
base unit with VS SUB pull out		single base units								single base units with pull-out waste bin (door is mounted to the bin - see page 117 for full details)						
150mm trays	300mm trays	150mm	300mm	350mm	400mm	450mm	500mm	500mm sink unit (includes base liner)	600mm	600mm sink unit (includes base liner)	300mm + bin (35L-1x35L)	400mm + bin (64L-2x32L)	450mm + bin (70L-2x35L)	500mm + bin (70L-2x35L)	600mm + bin (86L-4xbins)	600mm + bin (80L-2x40L)
BP15TY	BP3TY	BH15	BH30	BH35	BH40	BH45	BH50	BH50S	BH60	BH60S	BH3B	BH4B	BH45B	BH5B	BH6B4	BH6B2
£450	£709	£270	£314	£321	£327	£340	£362	£392	£402	£448	£682	£760	£778	£806	£935	£883

highline base units							highline corner units			
double base units							corner base units 800mm			corner base unit 900mm
700mm	800mm	800mm sink unit (includes base liner)	900mm	900mm sink unit (includes base liner)	1000mm	1000mm sink unit (includes base liner)	300mm door	400mm door	450mm door	450mm door
BH70	BH80	BH80S	BH90	BH90S	BH100	BH105	BC83	BC84	BC84S	BC94S
£540	£550	£596	£554	£600	£597	£643	£591	£600	£602	£602

highline corner units					
corner base units 1000mm		corner base units 1000mm with VS CORNERSTONE MAXX pull out		corner base units 900mm with VS COR FLEX pull out	
450mm door	500mm door	600mm door	500mm door	600mm door	450mm door
BC14S	BC15	BC16	BCL15L/R	BCL16L/R	BCO94S
£607	£626	£646	£1,384	£1,467	£1,505

highline corner units				feature base units			
corner base units 1000mm with VS COR FLEX pull out		950L corner base unit	curved end base unit	belfast sink unit (requires customisation)			
450mm door	500mm door	600mm door	950mm	320mm	600mm (495mm high door - for sinks up to 220mm high)	600mm (450mm high door - for sinks up to 265mm high)	800mm (495mm high doors - for sinks up to 220mm high)
BCO14S	BCO15	BCO16	BCL9	BHCV	BSU649S	BSU6450	BSU849S
£1,510	£1,529	£1,549	£823	£913	£334	£327	£484

drawerline base units										
Please state which drawer type you would like upon ordering	highline drawer unit with 1 pan drawer & 2 internal drawers				single base units				double base units	
	300mm	400mm	500mm	600mm	300mm	400mm	500mm	600mm	800mm	1000mm
	BHD3	BHD4	BHD5	BHD6	BDL3	BDL4	BDL5	BDL6	BDL8	BDL10
Excel	£703	£755	£819	£879	£451	£496	£524	£554	£888	£921
Legrabox	£1,043	£1,095	£1,159	£1,219	£551	£596	£624	£654	£1,088	£1,121
Oak	£1,073	£1,125	£1,189	£1,249	£561	£606	£634	£664	£1,108	£1,141

drawerline base units						drawerline corner units				
Please state which drawer type you would like upon ordering	double base units (1 drawer + 2 door)			corner base unit 800mm			corner base units 1000mm			
	800mm	900mm	1000mm	300mm door/drw	400mm door/drw	500mm door/drw	500mm door/drw	600mm door/drw		
	BDL81DW	BDL91DW	BDL101DW	BDLC83	BDLC84	BDLC85	BDLC15	BDLC16		
Excel	£769	£790	£815	£728	£769	£783	£788	£798		
Legrabox	£869	£890	£915	£828	£869	£883	£888	£898		
Oak	£879	£900	£925	£838	£879	£893	£898	£908		

drawer base units															
Please state which drawer type you would like upon ordering	4 drawer unit (1 pan)			3 drawer unit (2 pan)				2 drawer unit (2 pan)			2 drawer unit with internal drawer (2 pan)			low single drawer unit 360mm high	
	500mm	500mm	600mm	800mm	900mm	1000mm	600mm	800mm	900mm	1000mm	600mm	800mm	900mm	1000mm	600mm
	BD54	BD53	BD63	BD83	BD93	BD13	BD62	BD82	BD92	BD12	BD62I	BD82I	BD92I	BD12I	BD635L
Excel	£964	£830	£878	£959	£1,000	£1,048	£745	£764	£892	£910	£921	£957	£1,093	£1,116	£415
Legrabox	£1,404	£1,210	£1,258	£1,339	£1,380	£1,428	£1,025	£1,044	£1,172	£1,190	£1,301	£1,337	£1,473	£1,496	£555
Oak	£1,444	£1,240	£1,288	£1,369	£1,410	£1,458	£1,045	£1,064	£1,192	£1,210	£1,331	£1,367	£1,503	£1,526	£565

wall units (575mm, 720mm & 900mm high)												
	single wall units						double wall units				standard corner units	
	300mm	350mm	400mm	450mm	500mm	600mm	700mm	800mm	900mm	1000mm	600mm	900mm
575mm high	W357		W457	W4557	W557	W657		W857	W957	W157	WC657	WC957
	£275		£301	£309	£319	£336		£521	£523	£540	£457	£511
720mm high	W30	W35	W40	W45	W50	W60	W70	W80	W90	W100	WC6	WC9
	£296	£303	£313	£320	£345	£373	£535	£545	£545	£592	£446	£516
900mm high	TW30		TW40	TW45	TW50	TW60		TW80	TW90	TW100	TWC6	TWC9
	£365		£380	£386	£416	£415		£642	£646	£696	£533	£572

wall units (720mm high)					feature wall units								
'L' shaped wall units	bi-fold units				glass wall unit	glass dresser unit	1000mm wide 2 door breakfast dresser 400mm deep cabinet				curved end wall unit	microwave wall unit	boiler unit 900mm high
	600mm	800mm	900mm	1000mm	500mm	500mm	1210mm high (40mm w/top)	1220mm high (30mm w/top)	1225mm high (25mm w/top)	1230mm high (20mm w/top)	320mm	600mm	600mm door
WCL6S	WBI60	WBI80	WBI90	WBI10	WG5	WDR50	WDB100	WDB1001	WDB1002	WDB1003	WCV	WM60	WBHU
£682	£719	£773	£891	£912	£332	£826	£1,675	£1,675	£1,675	£1,675	£907	£471	£385

bridging units											
bridging units 285mm high (with Blum Aventos HK-S)						bridging units 360mm high (with Blum Aventos HK-S)					
600mm	800mm	900mm	1000mm	600mm	800mm	900mm	1000mm				
WB62	WB82	WB92	WB12	WB63	WB83	WB93	WB13				
£324	£410	£424	£442	£351	£391	£460	£471				

†† Unit supplied as standard with solid shelves, glass shelves extra. 500mm & 600mm glass shelf (8mm) £70 each.

** Curved unit filler door to be trimmed on site.

▲ This unit is made using a 330mm deep cabinet and requires the holes for the legs and drawer runners to be drilled on site.

+ Belfast sink cabinets are the correct height for a 495mm door, if a 450mm door is being used then the cabinet must be trimmed at the bottom. We also recommend you order door coloured material for the sink to sit on with the 495 door unit so that the cabinet is not visible around the edges of the sink.

Prices include soft close doors and drawers as standard (LochAnna Excel drawers). Handles must be purchased separately.

appliance housings - Note: see page 136 for full housing door configurations

	50/50 fridge freezer housing	70/30 fridge freezer housing	If ordering a housing with drawer, please state which drawer type you would like	double oven housing	double oven housing 2 drawer	double oven / micro housing 1 drawer	single oven housing	single oven housing 1 drawer
	600mm	600mm		600mm	600mm	600mm	600mm	600mm
	AH-F55	AH-F73		AH-DO	AH-DO2D	AH-DMW	AH-SO	AH-SO1D
Standard height 1968mm	£955	£949	Excel Legrabox Oak	£828	£1,153 £1,433 £1,453	£1,060 £1,200 £1,210	£899	£1,054 £1,154 £1,164
Extra Tall 2148mm	TAH-F55 £1,017	TAH-F73 £1,037	Excel Legrabox Oak	TAH-DO £1,023	TAH-DO2D £1,279 £1,559 £1,579		TAH-SO £1,031	

	If ordering a housing with drawer, please state which drawer type you would like	single oven housing 2 drawer	single oven housing 3 drawer	single oven / micro housing	single oven / micro housing 2 drawers	twin single oven housing	compact oven / microwave housing
		600mm	600mm	600mm	600mm	600mm	600mm
		AH-SO2D	AH-SO3D	AH-SMW	AH-SM2D	AH-SOT	AH-CO
Standard height 1968mm	Excel Legrabox Oak	£1,249 £1,529 £1,549	£1,398 £1,778 £1,808	£897	£1,190 £1,430 £1,450	£966 £1,106 £1,116	£1,012
Extra Tall 2148mm	Excel Legrabox Oak	TAH-SO2D £1,375 £1,655 £1,675		TAH-SMW £961		TAH-SOT £809	TAH-CO £1,028

built under housings

600 built under oven housing (drawer cannot be upgraded)

fixed panel	with drawer
£222	£335

over counter corner housings

If ordering a housing with drawer, please state which drawer type you would like

single oven housing	compact appliance / microwave housing	storage unit
600mm	600mm	600mm
CH-SO	CH-MW	CH-ST
Excel Legrabox Oak	£801 £901 £911	£1,039 £1,139 £1,149
TCH-SO	TCH-MW	TCH-ST
Excel Legrabox Oak	£944 £1,044 £1,054	£908 £1,122 £1,222 £1,232

larders

	larder unit 2 door				larder unit with VS TAL Larder pull out	
	300mm	400mm	500mm	600mm	300mm	400mm
	L3	L4	L5	L6	LP3	LP4
Standard height 1968mm	£805	£861	£925	£1,032	£1,592	£1,772
Extra Tall 2148mm	TL3	TL4	TL5	TL6	TLP3	TLP4
	£860	£912	£980	£1,057	£1,647	£1,823

larders

	larder unit with pull out oak dovetail drawers				larder drawer tower with excel plus glass drawers (supplied with 155° hinges) Note: this requires the 1245mm door to be fitted at the bottom			larder unit with VS TAL Gate Pro pull out		larder unit with VS TAL Gate pull out		diagonal corner larder 1016 x 1016mm
	300mm	400mm	500mm	600mm	300mm	500mm	600mm	500mm	600mm	500mm	600mm	600mm door
	LPD3	LPD4	LPD5	LPD6	LT3	LT5	LT6	LP5T	LP6T	LP5TS	LP6TS	LAC
Standard 1968mm	£1,885	£1,981	£2,045	£2,157	£1,906	£2,094	£2,267	£2,117	£2,218	£1,859	£2,019	£2,322
Extra Tall 2148mm	TLPD3	TLPD4	TLPD5	TLPD6	TLT3	TLT5	TLT6	TLP5T	TLP6T	TLP5TS	TLP6TS	TLAC
	£1,940	£2,032	£2,100	£2,182	£1,961	£2,149	£2,292	£2,172	£2,243	£1,914	£2,044	£2,706

The extra tall 1000mm larders have an additional top box which needs to be affixed to the top of the standard height unit to make it extra tall.

If ordering a larder with drawer, please state which drawer type you would like

	1000mm butler's pantry (oak & walnut cab only)	larder unit 4 doors	larder unit 4 doors 1 drawer	larder unit 2 doors 3 drawers	larder unit 2 doors 2 drawers	1000mm blind corner larder*		1000mm blind corner larder with VS CORNERSTONE MAXX pull out LH / RH (LH Shown)	
	1000mm	1000mm	1000mm	1000mm	1000mm	500mm door	600mm door	500mm door	600mm door
	LBP10	LPN14D	LPN14D1DW	LPN12D3DW	LPN12D2DW	LBC15	LBC16	LBCLM15L/R	LBCLM16L/R
Standard height 1968mm	Excel Legrabox Oak	£2,545 £2,925 £3,358	£1,528	£1,733 £1,833 £1,843	£1,972 £2,352 £2,134	£1,224	£1,286	£3,062	£3,250
Extra Tall 2148mm	Excel Legrabox Oak	TLBP10 £2,690 £3,070 £3,503	TLPN14D £1,737			TLBC15	TLBC16	TLBCLM15L/R	TLBCLM16L/R
						£1,397	£1,429	£3,235	£3,393

^{SD} Full height 1965mm doors available as follows: 300, 400, 500, 600mm = Elswick & Rowan 600mm = Clarkwell & Georgian

lifestyle larders

Our lifestyle larders can be customised, with different colour inner shelves & dividers and outer cabinets. They come automatically with both in the cabinet colour for the range chosen, simply indicate on your order what combination you'd like. The extra tall larders have an additional top box which needs to be affixed to the top of the standard height unit to make it extra tall.

	easy access larder	cleaning & utility larder	cleaning & utility larder	cleaning & utility larder - extra shelves	combi larder (this unit comes as standard with full height space in the centre, storage cubes can be added as optional extra)	laundry stacker larder
	600mm	600mm	1000mm	1000mm	1000mm	800mm
	LL6EA	LL6CU	LL10CU	LL10CUS	LL10CB	LL8LS
Standard height 1968mm	£1,074	£1,024	£1,639	£1,738	£1,649	£1,708
Extra Tall 2148mm	TLL6EA	TLL6CU	TLL10CU	TLL10CUS	TLL10CB	TLL8LS
	£1,175	£1,125	£1,848	£1,947	£1,858	£1,909

integrated appliance fascias

integrated extractor door	built under fridge / dw / washer door	integrated dishwasher door	semi integrated dishwasher door	boiler door	wall plant on panel	end support panel	tall plant on panel	large universal panel / breakfast bar back panel	breakfast bar back panel
450 x 600mm	715 x 600mm	715 x 450mm	570 x 600mm	895 x 600mm	960 x 360mm	900 x 650mm	2430 x 650mm	910 x 2450mm	900 x 1200mm
AD60ICH	AD60FD	AD45I	AD60S	BLD9	PWEP9	ESP	PTEP2	LUP	BBP
£139	£214	£175	£177	£236	£188	£188	£383	£487	£244

T&G panels

wall plant on panel	end support panel	tall plant on panel	large universal panel/breakfast bar back panel	breakfast bar back panel	accessories / trims		working mantle	
960 x 360mm	900 x 650mm	2430 x 650mm	910 x 2450mm	900 x 1200mm	open wall unit	wine rack	chopping boards & trays unit	Georgian / Clarkwell only
					500mm	150mm	720 x 200mm	1400 x 1600 420mm
PWEP9-TG	ESP-TG	PTEP2-TG	LUP-TG	BBP-TG	570U	WR72	CBTR	WM16
£241	£241	£552	£595	£300	£188	£200	£1,530	£3,066

accessories / trims

mantle shelf	shelf bracket (1 no.)	plate rack (oak only)	wine rack rail (oak only)	modular pilaster		modular pilaster bead	optional corner unit adjustment filler panel (for use when more than 80x80 is required)
1752 x 130 x 170mm	166 x 125 x 21mm	1200 x 336 x 23mm to be cut to size	1200 x 63mm to be cut to size	900 x 75mm	2400 x 75mm	910 x 20mm	715 x 147mm
MTS17	SHB	PRK	WRK	MP900	MP2400	MPBD	CKP
£696	£120	£240	£73	£196	£373	£70	£107

accessories / trims

plinth	curved plinth	stepped skirting plinth	curved stepped skirting plinth**	under plinth	curved under plinth	feature plinth	traditional cornice	traditional curved cornice	angled cornice	angled curved cornice	traditional pelmet	traditional curved pelmet
3050 x 150mm	506 x 366mm	2450 x 150mm	150 x 430 x 430mm	3000 x 60mm	570 x 318mm	2500 x 150 x 9mm	3050 x 81 x 65mm	430 x 430 x 65mm	3050 x 65 x 41mm	321 x 321 x 41mm	3050 x 29 x 55mm	430 x 430 x 55mm
PL	CVPL	SKPL	CVSTPL	UDPL	CVUDPL	FTPL	SCCRN	CVSCRN	ACRN	CVACRN	SCPEL	CVSPEL
£168	£205	£357	£697	£168	£261	£168	£153	£243	£148	£198	£148	£198

accessories / trims

universal cornice / pelmet	modern curved pelmet	tall feature end post	curved end post	traditional cornice curved end post cap	angled cornice curved end post cap	curved end post base cap	edging tape roll (veneered)	touch up paint	care kit	touch up paint 1L tin
3050 x 60 x 35mm	321 x 321 x 35mm	3050 x 60 x 35mm	2450 x 50 x 70mm	92 x 92 x 65mm	111 x 111 x 41mm	150 x 64 x 64mm	oak (10m) unfinished	20ml	includes pen, soft wax & applicator, scotchbrite pad	1 litre
CORPEL	CVPEL	FEP	CVP	CPBT	ACPBT	CVEBC	ET	TUP	CK	TUP-1L
£148	£198	£136	£167	£137	£109	£279	£35	£46	£81	£136

See pages 10-11 for cabinet colour supplied as standard. Please specify cabinet colour when ordering. Handle options - see pages 58-62. See page 10-11 for lead times.

* If installing alongside base units you must order a tall plant on panel. See page 141 for technical information.

** Curved stepped skirting plinth is on an 8 week lead time

t Available in either 1600mm or 1800mm widths. Height of 1400mm does not include cornice

▲ Touch up paints and care kits should only be used for minor repairs to backs and edges of doors. They should not be used on door fronts

Prices include soft close doors and drawers as standard (LochAnna Excel drawers). Handles must be purchased separately.

highline base units																
base unit with VS SUB pull out		single base units								single base units with pull-out waste bin (door is mounted to the bin - see page 117 for full details)						
150mm trays	300mm trays	150mm	300mm	350mm	400mm	450mm	500mm	500mm sink unit (includes base liner)	600mm	600mm sink unit (includes base liner)	300mm + bin (35L-1x35L)	400mm + bin (64L-2x32L)	450mm + bin (70L-2x35L)	500mm + bin (70L-2x35L)	600mm + bin (86L-4xbins)	600mm + bin (80L-2x40L)
BP15TY	BP3TY	BH15	BH30	BH35	BH40	BH45	BH50	BH50S	BH60	BH60S	BH3B	BH4B	BH45B	BH5B	BH6B4	BH6B2
£450	£709	£270	£314	£321	£327	£340	£362	£392	£402	£448	£682	£760	£778	£806	£935	£883

highline base units							highline corner units				
double base units							corner base units 800mm				corner base unit 900mm
700mm	800mm	800mm sink unit (includes base liner)	900mm	900mm sink unit (includes base liner)	1000mm	1000mm sink unit (includes base liner)	300mm door	400mm door	450mm door	450mm door	
BH70	BH80	BH80S	BH90	BH90S	BH100	BH105	BC83	BC84	BC84S	BC94S	
£540	£550	£596	£554	£600	£597	£643	£591	£600	£602	£602	

highline corner units					
corner base units 1000mm		corner base units 1000mm with VS CORNERSTONE MAXX pull out		corner base units 900mm with VS COR FLEX pull out	
450mm door	500mm door	600mm door	500mm door	600mm door	450mm door
BC14S	BC15	BC16	BCL15L/R	BCL16L/R	BCO94S
£607	£626	£646	£1,384	£1,467	£1,505

highline corner units			feature base units				
corner base units 1000mm with VS COR FLEX pull out		950L corner base unit	curved end base unit	belfast sink unit (requires customisation)			
450mm door	500mm door	600mm door	950mm	320mm	600mm (495mm high door - for sinks up to 220mm high)	600mm (450mm high door - for sinks up to 265mm high)	800mm (495mm high doors - for sinks up to 220mm high)
BCO14S	BCO15	BCO16	BCL9	BHCV	BSU649S	BSU6450	BSU849S
£1,510	£1,529	£1,549	£823	£913	£334	£327	£484

drawerline base units											
Please state which drawer type you would like upon ordering	highline drawer unit with 1 pan drawer & 2 internal drawers				single base units				double base units		
	300mm	400mm	500mm	600mm	300mm	400mm	500mm	600mm	800mm	1000mm	
	BHD3	BHD4	BHD5	BHD6	BDL3	BDL4	BDL5	BDL6	BDL8	BDL10	
Excel	£703	£755	£819	£879	£451	£496	£524	£554	£888	£921	
Legrabox	£1,043	£1,095	£1,159	£1,219	£551	£596	£624	£654	£1,088	£1,121	
Oak	£1,073	£1,125	£1,189	£1,249	£561	£606	£634	£664	£1,108	£1,141	

drawerline base units						drawerline corner units				
Please state which drawer type you would like upon ordering	double base units (1 drawer + 2 door)			corner base unit 800mm			corner base units 1000mm			
	800mm	900mm	1000mm	300mm door/drw	400mm door/drw	500mm door/drw	500mm door/drw	600mm door/drw		
	BDL81DW	BDL91DW	BDL101DW	BDLC83	BDLC84	BDLC85	BDLC15	BDLC16		
Excel	£769	£790	£815	£728	£769	£783	£788	£798		
Legrabox	£869	£890	£915	£828	£869	£883	£888	£898		
Oak	£879	£900	£925	£838	£879	£893	£898	£908		

drawer base units															
Please state which drawer type you would like upon ordering	4 drawer unit (1 pan)			3 drawer unit (2 pan)				2 drawer unit (2 pan)			2 drawer unit with internal drawer (2 pan)			low single drawer unit 360mm high	
	500mm	500mm	600mm	800mm	900mm	1000mm	600mm	800mm	900mm	1000mm	600mm	800mm	900mm	1000mm	600mm
	BD54	BD53	BD63	BD83	BD93	BD13	BD62	BD82	BD92	BD12	BD62I	BD82I	BD92I	BD12I	BD635L
Excel	£964	£830	£878	£959	£1,000	£1,048	£745	£764	£892	£910	£921	£957	£1,093	£1,116	£415
Legrabox	£1,404	£1,210	£1,258	£1,339	£1,380	£1,428	£1,025	£1,044	£1,172	£1,190	£1,301	£1,337	£1,473	£1,496	£555
Oak	£1,444	£1,240	£1,288	£1,369	£1,410	£1,458	£1,045	£1,064	£1,192	£1,210	£1,331	£1,367	£1,503	£1,526	£565

wall units (575mm, 720mm & 900mm high)												
	single wall units						double wall units				standard corner units	
	300mm	350mm	400mm	450mm	500mm	600mm	700mm	800mm	900mm	1000mm	600mm	900mm
575mm high	W357		W457	W4557	W557	W657		W857	W957	W157	WC657	WC957
	£275		£301	£309	£319	£336		£521	£523	£540	£457	£511
720mm high	W30	W35	W40	W45	W50	W60	W70	W80	W90	W100	WC6	WC9
	£296	£303	£313	£320	£345	£373	£535	£545	£545	£592	£446	£516
900mm high	TW30		TW40	TW45	TW50	TW60		TW80	TW90	TW100	TWC6	TWC9
	£365		£380	£386	£416	£415		£642	£646	£696	£533	£572

wall units (720mm high)					feature wall units								
'L' shaped wall units	bi-fold units				glass wall unit	glass dresser unit	1000mm wide 2 door breakfast dresser 400mm deep cabinet				curved end wall unit	microwave wall unit	boiler unit 900mm high
	600mm	800mm	900mm	1000mm	500mm	500mm	1210mm high (40mm w/top)	1220mm high (30mm w/top)	1225mm high (25mm w/top)	1230mm high (20mm w/top)	320mm	600mm	600mm door
WCL65	WBI60	WBI80	WBI90	WBI10	WG5	WDR50	WDB100	WDB1001	WDB1002	WDB1003	WCV	WM60	WBHU
£682	£719	£773	£891	£912	£332	£826	£1,675	£1,675	£1,675	£1,675	£907	£471	£385

bridging units											
bridging units 285mm high (with Blum Aventos HK-S)						bridging units 360mm high (with Blum Aventos HK-S)					
600mm	800mm	900mm	1000mm	600mm	800mm	900mm	1000mm				
WB62	WB82	WB92	WB12	WB63	WB83	WB93	WB13				
£324	£410	£424	£442	£351	£391	£460	£471				

†† Unit supplied as standard with solid shelves, glass shelves extra. 500mm & 600mm glass shelf (8mm) £70 each.

** Curved unit filler door to be trimmed on site.

▲ This unit is made using a 330mm deep cabinet and requires the holes for the legs and drawer runners to be drilled on site.

+ Belfast sink cabinets are the correct height for a 495mm door, if a 450mm door is being used then the cabinet must be trimmed at the bottom. We also recommend you order door coloured material for the sink to sit on with the 495 door unit so that the cabinet is not visible around the edges of the sink.

Prices include soft close doors and drawers as standard (LochAnna Excel drawers). Handles must be purchased separately.

appliance housings - Note: see page 136 for full housing door configurations

	50/50 fridge freezer housing	70/30 fridge freezer housing	If ordering a housing with drawer, please state which drawer type you would like	double oven housing	double oven housing 2 drawer	double oven / micro housing 1 drawer	single oven housing	single oven housing 1 drawer
	600mm	600mm		600mm	600mm	600mm	600mm	600mm
	AH-F55	AH-F73		AH-DO	AH-DO2D	AH-DMW	AH-SO	AH-SO1D
Standard height 1968mm	£955	£949	Excel Legrabox Oak	£828	£1,153 £1,433 £1,453	£1,060 £1,200 £1,210	£899	£1,054 £1,154 £1,164
Extra Tall 2148mm	TAH-F55 £1,017	TAH-F73 £1,037	Excel Legrabox Oak	TAH-DO £1,023	TAH-DO2D £1,279 £1,559 £1,579		TAH-SO £1,031	

	If ordering a housing with drawer, please state which drawer type you would like	single oven housing 2 drawer	single oven housing 3 drawer	single oven / micro housing	single oven / micro housing 2 drawers	twin single oven housing	compact oven / microwave housing
		600mm	600mm	600mm	600mm	600mm	600mm
		AH-SO2D	AH-SO3D	AH-SMW	AH-SM2D	AH-SOT	AH-CO
Standard height 1968mm	Excel Legrabox Oak	£1,249 £1,529 £1,549	£1,398 £1,778 £1,808	£897	£1,190 £1,430 £1,450	£966 £1,106 £1,116	£1,012
Extra Tall 2148mm	Excel Legrabox Oak	TAH-SO2D £1,375 £1,655 £1,675		TAH-SMW £961		TAH-SOT £809	TAH-CO £1,028

	over counter corner housings			larders							
	single oven housing	compact appliance / microwave housing	storage unit	larder unit 2 door				larder unit with VS TAL Larder pull out			
	600mm	600mm	600mm	300mm	400mm	500mm	600mm	300mm	400mm		
	CH-SO	CH-MW	CH-ST	L3	L4	L5	L6	LP3	LP4		
Standard height 1968mm	Excel Legrabox Oak	£801 £901 £911	£1,039 £1,139 £1,149	£805	£861	£925	£1,032	£1,592	£1,772		
Extra Tall 2148mm	Excel Legrabox Oak	TCH-SO £944 £1,044 £1,054	TCH-MW £908 £1,122 £1,222 £1,232	TL3	TL4	TL5	TL6	TLP3	TLP4		
	BOH6	BOHD6		£860	£912	£980	£1,057	£1,647	£1,823		

	The extra tall 1000mm larders have an additional top box which needs to be affixed to the top of the standard height unit to make it extra tall. If ordering a larder with drawer, please state which drawer type you would like	1000mm butler's pantry (oak & walnut cab only)	larder unit 4 doors	larder unit 4 doors 1 drawer	larder unit 2 doors 3 drawers	larder unit 2 doors 2 drawers	1000mm blind corner larder*	1000mm blind corner larder with VS CORNERSTONE MAXX pull out LH / RH (LH Shown)
		1000mm	1000mm	1000mm	1000mm	1000mm	500mm door	600mm door
		LBP10	LPN14D	LPN14D1DW	LPN12D3DW	LPN12D2DW	LBC15	LBC16
Standard height 1968mm	Excel Legrabox Oak	£2,545 £2,925 £3,358	£1,528	£1,733 £1,833 £1,843	£1,972 £2,352 £2,382	£1,834 £2,114 £2,134	£1,224	£1,286
Extra Tall 2148mm	Excel Legrabox Oak	TLBP10 £2,690 £3,070 £3,503	TLPN14D £1,737				TLBC15 £1,397	TLBC16 £1,429
							LBCLM15L/R £3,062	LBCLM16L/R £3,250

^{SD} Full height 1965mm doors available as follows: 300, 400, 500, 600mm = Elswick & Rowan 600mm = Clarkwell & Georgian

lifestyle larders

	easy access larder	cleaning & utility larder	cleaning & utility larder	cleaning & utility larder - extra shelves	combi larder (this unit comes as standard with full height space in the centre, storage cubes can be added as optional extra)	laundry stacker larder
	600mm	600mm	1000mm	1000mm	1000mm	800mm
	LL6EA	LL6CU	LL10CU	LL10CUS	LL10CB	LL8LS
Standard height 1968mm	£1,074	£1,024	£1,639	£1,738	£1,649	£1,708
Extra Tall 2148mm	TLL6EA £1,175	TLL6CU £1,125	TLL10CU £1,848	TLL10CUS £1,947	TLL10CB £1,858	TLL8LS £1,909

integrated appliance fascias					plain panels				
integrated extractor door	built under fridge / dw / washer door	integrated dishwasher door	semi integrated dishwasher door	boiler door	wall plant on panel	end support panel	tall plant on panel	large universal panel / breakfast bar back panel	breakfast bar back panel
450 x 600mm	715 x 600mm	715 x 450mm	570 x 600mm	895 x 600mm	960 x 360mm	900 x 650mm	2430 x 650mm	910 x 2450mm	900 x 1200mm
AD60ICH	AD60FD	AD45I	AD60S	BLD9	PWEP9	ESP	PTEP2	LUP	BBP
£139	£214	£175	£177	£236	£188	£188	£383	£487	£244

T&G panels				framed panels (valina only)			accessories / trims		
wall plant on panel	end support panel	tall plant on panel	large universal panel/breakfast bar back panel	breakfast bar back panel	small island end pane	large island end pane	open wall unit	wine rack	chopping boards & trays unit
960 x 360mm	900 x 650mm	2430 x 650mm	910 x 2450mm	900 x 1200mm	720 x 900mm	720 x 1200mm	500mm	150mm	720 x 200mm
PWEP9-TG	ESP-TG	PTEP2-TG	LUP-TG	BBP-TG	FREP9	FREP12	57OU	WR72	CBTR
£241	£241	£552	£595	£300	£300	£570	£188	£200	£1,530

accessories / trims							
mantle shelf	shelf bracket (1 no.)	plate rack (oak only)	wine rack rail (oak only)	modular pilaster		modular pilaster bead	optional corner unit adjustment filler panel (for use when more than 80x80 is required)
1752 x 130 x 170mm	166 x 125 x 21mm	1200 x 336 x 23mm to be cut to size	1200 x 63mm to be cut to size	900 x 75mm	2400 x 75mm	910 x 20mm	715 x 147mm
MTS17	SHB	PRK	WRK	MP900	MP2400	MPBD	CKP
£696	£120	£240	£73	£196	£373	£70	£107

accessories / trims												
plinth	curved plinth	stepped skirting plinth	curved stepped skirting plinth**	under plinth	curved under plinth	feature plinth	traditional cornice	traditional curved cornice	angled cornice	angled curved cornice	traditional pelmet	traditional curved pelmet
3050 x 150mm	506 x 366mm	2450 x 150mm	150 x 430 x 430mm	3000 x 60mm	570 x 318mm	2500 x 150 x 9mm	3050 x 81 x 65mm	430 x 430 x 65mm	3050 x 65 x 41mm	321 x 321 x 41mm	3050 x 29 x 55mm	430 x 430 x 55mm
PL	CVPL	SKPL	CVSTPL	UDPL	CVUDPL	FTPL	SCCRN	CVSCRN	ACRN	CVACRN	SCPEL	CVSPEL
£168	£205	£357	£697	£168	£261	£168	£153	£243	£148	£198	£148	£198

accessories / trims											
universal cornice / pelmet	modern curved pelmet	tall feature end post	curved end post	traditional cornice curved end post cap	angled cornice curved end post cap	curved end post base cap	edging tape roll (veneered)	touch up paint	care kit	touch up paint 1L tin	
3050 x 60 x 35mm	321 x 321 x 35mm	3050 x 60 x 35mm	2450 x 50 x 70mm	92 x 92 x 65mm	111 x 111 x 41mm	150 x 64 x 64mm	oak (10m) unfinished	20ml	includes pen, soft wax & applicator, scotchbrite pad	1 litre	
CORPEL	CVPEL	FEP	CVP	CPBT	ACPBT	CVEBC	ET	TUP	CK	TUP-1L	
£148	£198	£136	£167	£137	£109	£279	£35	£46	£81	£136	

See pages 10-11 for cabinet colour supplied as standard. Please specify cabinet colour when ordering. Handle options - see pages 58-62. See page 10-11 for lead times.

* If installing alongside base units you must order a tall plant on panel. See page 141 for technical information.

** Curved stepped skirting plinth is on an 8 week lead time

t Available in either 1600mm or 1800mm widths. Height of 1400mm does not include cornice

▲ Touch up paints and care kits should only be used for minor repairs to backs and edges of doors. They should not be used on door fronts

Prices include soft close doors and drawers as standard (LochAnna Excel drawers). Handles must be purchased separately.

highline base units																
base unit with VS SUB pull out		single base units								single base units with pull-out waste bin (door is mounted to the bin - see page 117 for full details)						
150mm trays	300mm trays	150mm	300mm	350mm	400mm	450mm	500mm	500mm sink unit (includes base liner)	600mm	600mm sink unit (includes base liner)	300mm + bin (35L-1x35L)	400mm + bin (64L-2x32L)	450mm + bin (70L-2x35L)	500mm + bin (70L-2x35L)	600mm + bin (86L-4xbins)	600mm + bin (80L-2x40L)
BP15TY	BP3TY	BH15	BH30	BH35	BH40	BH45	BH50	BH50S	BH60	BH60S	BH3B	BH4B	BH45B	BH5B	BH6B4	BH6B2
£471	£738	£291	£343	£346	£355	£369	£398	£428	£440	£486	£711	£788	£807	£842	£973	£921

highline base units							highline corner units				
double base units							corner base units 800mm				corner base unit 900mm
700mm	800mm	800mm sink unit (includes base liner)	900mm	900mm sink unit (includes base liner)	1000mm	1000mm sink unit (includes base liner)	300mm door	400mm door	450mm door	450mm door	
BH70	BH80	BH80S	BH90	BH90S	BH100	BH10S	BC83	BC84	BC84S	BC94S	
£590	£606	£652	£612	£658	£669	£715	£620	£628	£631	£631	

highline corner units					
corner base units 1000mm			corner base units 1000mm with VS CORNERSTONE MAXX pull out		corner base units 900mm with VS COR FLEX pull out
450mm door	500mm door	600mm door	500mm door	600mm door	450mm door
BC14S	BC15	BC16	BCL15L/R	BCL16L/R	BCO94S
£636	£662	£684	£1,420	£1,505	£1,534

highline corner units				feature base units			
corner base units 1000mm with VS COR FLEX pull out			950L corner base unit	curved end base unit (washington only)	belfast sink unit (requires customisation)		
450mm door	500mm door	600mm door	950mm	320mm	600mm (495mm high door - for sinks up to 220mm high)	600mm (450mm high door - for sinks up to 265mm high)	800mm (495mm high doors - for sinks up to 220mm high)
BCO14S	BCO15	BCO16	BCL9	BHCV	BSU649S	BSU6450	BSU849S
£1,539	£1,565	£1,587	£881	£1,142	£361	£351	£484

drawerline base units										
Please state which drawer type you would like upon ordering	highline drawer unit with 1 pan drawer & 2 internal drawers				single base units				double base units	
	300mm	400mm	500mm	600mm	300mm	400mm	500mm	600mm	800mm	1000mm
Excel	BHD3	BHD4	BHD5	BHD6	BDL3	BDL4	BDL5	BDL6	BDL8	BDL10
£732	£783	£855	£917	£482	£533	£584	£594	£962	£1,041	
Legrabox	£1,072	£1,123	£1,195	£1,257	£582	£633	£684	£694	£1,162	£1,241
Oak	£1,102	£1,153	£1,225	£1,287	£592	£643	£694	£704	£1,182	£1,261

Please state which drawer type you would like upon ordering	drawerline base units			drawerline corner units				
	double base units (1 drawer + 2 door)			corner base unit 800mm			corner base units 1000mm	
	800mm	900mm	1000mm	300mm door/drw	400mm door/drw	500mm door/drw	500mm door/drw	600mm door/drw
Excel	BDL81DW	BDL91DW	BDL101DW	BDLC83	BDLC84	BDLC85	BDLC15	BDLC16
£839	£886	£933	£759	£806	£843	£848	£838	
Legrabox	£939	£986	£1,033	£859	£906	£943	£948	£938
Oak	£949	£996	£1,043	£869	£916	£953	£958	£948

drawer base units															
Please state which drawer type you would like upon ordering	4 drawer unit (1 pan)	3 drawer unit (2 pan)					2 drawer unit (2 pan)				2 drawer unit with internal drawer (2 pan)				low single drawer unit 360mm high
	500mm	500mm	600mm	800mm	900mm	1000mm	600mm	800mm	900mm	1000mm	600mm	800mm	900mm	1000mm	600mm
Excel	BD54	BD53	BD63	BD83	BD93	BD13	BD62	BD82	BD92	BD12	BD62I	BD82I	BD92I	BD12I	BD635L
£1,006	£869	£925	£1,017	£1,062	£1,114	£797	£866	£968	£992	£973	£1,059	£1,169	£1,198	£441	
Legrabox	£1,446	£1,249	£1,305	£1,397	£1,442	£1,494	£1,077	£1,146	£1,248	£1,272	£1,353	£1,439	£1,549	£1,578	£581
Oak	£1,486	£1,279	£1,335	£1,427	£1,472	£1,524	£1,097	£1,166	£1,268	£1,292	£1,383	£1,469	£1,579	£1,608	£591

wall units (575mm, 720mm & 900mm high)													
	single wall units						double wall units				standard corner units		
	300mm	350mm	400mm	450mm	500mm	600mm	700mm	800mm	900mm	1000mm	600mm	900mm	
575mm high	W357		W457	W4557	W557	W657		W857	W957	W157	WC657	WC957	
£291		£331	£349	£370	£367		£581	£603	£642	£473	£542		
720mm high	W30	W35	W40	W45	W50	W60	W70	W80	W90	W100	WC6	WC9	
£325	£328	£341	£349	£381	£411	£585	£601	£603	£664	£475	£554		
900mm high	TW30		TW40	TW45	TW50	TW60		TW80	TW90	TW100	TWC6	TWC9	
£395		£412	£417	£448	£451		£706	£708	£760	£563	£608		

wall units (720mm high)					feature wall units				
'L' shaped wall units	bi-fold units				glass wall unit (oak & walnut cab only)	curved end wall unit (washington only)	microwave wall unit	boiler unit 900mm high	
650mm	600mm	800mm	900mm	1000mm	500mm	320mm	600mm	600mm door	
WCL6S	WBI60	WBI80	WBI90	WBI10	WG5	WCV	WM60	WBHU	
£718	£777	£877	£967	£994	£517	£1,074	£511	£421	

bridging units											
bridging units 285mm high (with Blum Aventos HK-S)						bridging units 360mm high (with Blum Aventos HK-S)					
600mm	800mm	900mm	1000mm	600mm	800mm	900mm	1000mm	600mm	800mm	900mm	1000mm
WB62	WB82	WB92	WB12	WB63	WB83	WB93	WB13				
£348	£446	£460	£483	£380	£443	£498	£512				

* Belfast sink cabinets are the correct height for a 495mm door, if a 450mm door is being used then the cabinet must be trimmed at the bottom. We also recommend you order door coloured material for the sink to sit on with the 495 door unit so that the cabinet is not visible around the edges of the sink.

†† Unit supplied as standard with solid shelves, glass shelves extra. 500mm & 600mm glass shelf (8mm) £70 each.

*+ Curved unit filler door to be trimmed on site.

▲ This unit is made using a 330mm deep cabinet and requires the holes for the legs and drawer runners to be drilled on site.

Prices include soft close doors and drawers as standard (LochAnna Excel drawers). Handles must be purchased separately.

appliance housings - Note: see page 136 for full housing door configurations

	50/50 fridge freezer housing	70/30 fridge freezer housing	If ordering a housing with drawer, please state which drawer type you would like	double oven housing	double oven housing 2 drawer	double oven / micro housing 1 drawer	single oven housing	single oven housing 1 drawer
	600mm	600mm		600mm	600mm	600mm	600mm	600mm
	AH-F55	AH-F73		AH-DO	AH-DO2D	AH-DMW	AH-SO	AH-SO1D
Standard height 1968mm	£1,043	£1,043	Excel Legrabox Oak	£886	£1,218 £1,498 £1,518	£1,119 £1,259 £1,269	£1,025	£1,128 £1,228 £1,238
Extra Tall 2148mm	TAH-F55	TAH-F73	Excel Legrabox Oak	TAH-DO	TAH-DO2D		TAH-SO	
	£1,109	£1,154		£1,098	£1,367 £1,647 £1,667		£1,123	

	If ordering a housing with drawer, please state which drawer type you would like	single oven housing 2 drawer	single oven housing 3 drawer	single oven / micro housing	single oven / micro housing 2 drawers	twin single oven housing	compact oven / microwave housing
		600mm	600mm	600mm	600mm	600mm	600mm
		AH-SO2D	AH-SO3D	AH-SMW	AH-SM2D	AH-SOT	AH-CO
Standard height 1968mm	Excel Legrabox Oak	£1,332 £1,612 £1,632	£1,486 £1,866 £1,896	£961	£1,258 £1,498 £1,518	£1,025 £1,165 £1,175	£1,104
Extra Tall 2148mm	Excel Legrabox Oak	TAH-SO2D		TAH-SMW		TAH-SOT	TAH-CO
		£1,481 £1,761 £1,781		£1,035		£860	£1,124

built under housings		over counter corner housings		
600 built under oven housing (drawer cannot be upgraded)		single oven housing	compact appliance / microwave housing	storage unit
fixed panel	with drawer	600mm	600mm	600mm
		CH-SO	CH-MW	CH-ST
		£765	£846 £946 £956	£1,108 £1,208 £1,218
		TCH-SO	TCH-MW	TCH-ST
		£996	£976	£1,203 £1,303 £1,313
BOH6	BOHD6			
£238	£351			

larders		larder unit 2 door (full height door available in Thistleton only)				larder unit with VS TAL Larder pull out	
		300mm	400mm	500mm	600mm	300mm	400mm
Standard height 1968mm		L3	L4	L5	L6	LP3	LP4
		£869	£922	£991	£1,126	£1,656	£1,833
Extra Tall 2148mm		TL3	TL4	TL5	TL6	TLP3	TLP4
		£925	£977	£1,042	£1,149	£1,712	£1,888

	larder unit with pull out oak dovetail drawers				larder drawer tower with excel plus glass drawers (supplied with 155° hinges) Note: this requires the 1245mm door to be fitted at the bottom			larder unit with VS TAL Gate Pro pull out		larder unit with VS TAL Gate pull out		diagonal corner larder 1016 x 1016mm
	300mm	400mm	500mm	600mm	300mm	500mm	600mm	500mm	600mm	500mm	600mm	600mm door
Standard 1968mm	LPOD3	LPOD4	LPOD5	LPOD6	LT3	LT5	LT6	LP5T	LP6T	LP5TS	LP6TS	LAC
	£1,949	£2,042	£2,111	£2,251	£1,970	£2,160	£2,361	£2,183	£2,312	£1,925	£2,113	£2,416
Extra Tall 2148mm	TLPOD3	TLPOD4	TLPOD5	TLPOD6	TLT3	TLT5	TLT6	TLP5T	TLP6T	TLP5TS	TLP6TS	TLAC
	£2,005	£2,097	£2,162	£2,274	£2,026	£2,211	£2,384	£2,234	£2,335	£1,976	£2,136	£2,798

	The extra tall 1000mm larders have an additional top box which needs to be affixed to the top of the standard height unit to make it extra tall.	1000mm butler's pantry (oak & walnut cab only)	larder unit 4 doors	larder unit 4 doors 1 drawer	larder unit 2 doors 3 drawers	larder unit 2 doors 2 drawers	glass drinks pantry 4 doors	glass drinks pantry 4 doors 1 drawer	glass drinks pantry 2 doors 3 drawers	glass drinks pantry 2 doors 2 drawers	1000mm blind corner larder*		
		1000mm	1000mm	1000mm	1000mm	1000mm	1000mm	1000mm	1000mm	1000mm	500mm door	600mm door	
		wicker baskets £82 (each) spice racks £630 (pair)	LBP10	LPN14D	LPN14D1DW	LPN12D3DW	LPN12D2DW	LDP14D	LDP14D1DW	LDP12D3DW	LDP12D2DW	LBC15	LBC16
Standard height 1967mm	Excel Legrabox Oak	£2,677 £3,057 £3,490	£1,660	£1,911 £2,011 £2,021	£2,098 £2,478 £2,508	£1,976 £2,256 £2,276	£2,473	£2,699 £2,799 £2,809	£2,911 £3,291 £3,321	£2,789 £3,069 £3,089	£1,290	£1,380	
Extra Tall 2148mm	Excel Legrabox Oak	TLBP10	TLPN14D									TLBC15	TLBC16
		£2,814 £3,194 £3,627	£1,861									£1,459	£1,521

SD Full height larder doors available in Thistleton only, standard height larders only. * If installing alongside base units you must order a tall plant on panel. See page 141 for technical information.

larders - Continued		lifestyle larders					
1000mm blind corner larder with VS CORNERSTONE MAXX pull out LH / RH (LH Shown)		easy access larder	cleaning & utility larder	cleaning & utility larder	cleaning & utility larder - extra shelves	combi larder (this unit comes as standard with full height space in the centre, storage cubes can be added as optional extra)	laundry stacker larder
500mm door	600mm door	600mm	600mm	1000mm	1000mm	1000mm	800mm
		LL6EAL	LL6CU	LL10CU	LL10CUS	LL10CB	LL8LS
£3,128	£3,344	£1,168	£1,118	£1,771	£1,870	£1,781	£1,830
TLBCLM15L/R	TLBCLM16L/R	TLL6EA	TLL6CU	TLL10CU	TLL10CUS	TLL10CB	TLL8LS
£3,297	£3,485	£1,267	£1,217	£1,972	£2,071	£1,982	£2,039

integrated appliance fascias					plain panels				
integrated extractor door	built under fridge / dw / washer door	integrated dishwasher door	semi integrated dishwasher door	boiler door	wall plant on panel	end support panel	tall plant on panel	large universal panel / breakfast bar back panel	small breakfast bar back panel
450 x 600mm	715 x 600mm	715 x 450mm	570 x 600mm	895 x 600mm	960 x 360mm	900 x 650mm	2430 x 650mm	910 x 2450mm	900 x 1200mm
AD60ICH	AD60FD	AD45I	AD60S	BLD9	PWEP96	ESP	PTEP2	LUP	BBP
£163	£252	£204	£208	£272	£188	£188	£480	£624	£314

beaded panels					accessories / trims				
wall plant on panel	end support panel	tall plant on panel	large universal panel / breakfast bar back panel	small breakfast bar back panel	open wall unit	wine rack	flyover shelf	shelf bracket (1 no.)	edge moulding
960 x 360mm	900 x 650mm	2430 x 650mm	910 x 2450mm	900 x 1200mm	500mm	150mm	2400 x 325 25mm	180 x 140 35mm	3050 x 47.5 27mm
PWEP9-BD	ESP-BD	PTEP2-BD	LUP-BD	BBP-BD	57OU	WR72	FLSH	SHB	EDGM
£241	£241	£525	£624	£300	£188	£200	£488	£120	£136

accessories / trims									
mantle shelf	plate rack (oak only)	wine rack rail (oak only)	modular pilaster	optional corner unit adjustment filler panel (for use when more than 80x80 is required)	plinth	curved plinth	modern stepped skirting plinth	under plinth	curved under plinth
2500 x 196 x 202mm	1200 x 336 x 23mm to be cut to size	1200 x 63mm to be cut to size	900 x 75mm	715 x 147mm	3050 x 150mm	506 x 366mm	2450 x 150mm	3000 x 60mm	570 x 318mm
MTSK	PRK	WRK	MP900	CKP	PL	CVPL	SKPL	UDPL	CVUDPL
£841	£240	£73	£196	£107	£168	£205	£359	£168	£261

accessories / trims											
feature plinth	universal cornice / pelmet	traditional cornice	traditional curved cornice	traditional pelmet	curved pelmet	tall feature end post	curved end post	traditional cornice curved end post cap	touch up paint	care kit	touch up paint 1L tin
2500 x 150 x 9mm	3000 x 28 x 50mm	3050 x 81 x 65mm	430 x 430 x 65mm	3050 x 37 x 55mm	430 x 430 x 55mm	3050 x 60 x 35mm	2450 x 50 x 70mm	92 x 92 x 65mm	20ml	includes pen, soft wax & applicator, scotchbrite pad	1 Litre
FTPL	SQPEL	SCCRN	CVSCRN	SCPEL	CVSPEL	FEP	CVP	CPBT	TUP	CK	TUP-1L
£168	£194	£153	£243	£148	£198	£136	£167	£137	£46	£81	£136

Prices include soft close doors and drawers as standard (LochAnna Excel drawers).

highline base units																
base unit with VS SUB pull out		single base units								single base units with pull-out waste bin (door is mounted to the bin - see page 117 for full details)						
150mm trays	300mm trays	150mm	300mm	350mm	400mm	450mm	500mm	500mm sink unit (includes base liner)	600mm	600mm sink unit (includes base liner)	300mm + bin (35L-1x35L)	400mm + bin (64L-2x32L)	450mm + bin (70L-2x35L)	500mm + bin (70L-2x35L)	600mm + bin (86L-4xbins)	600mm + bin (80L-2x40L)
BP15TY	BP3TY	BH15L/R	BH30L/R	BH35L/R	BH40L/R	BH45L/R	BH50L/R	BH50SL/R	BH60L/R	BH60SL/R	BH3B	BH4B	BH45B	BH5B	BH6B4	BH6B2
£471	£738	£291	£343	£346	£355	£369	£398	£428	£440	£486	£711	£788	£807	£842	£921	£973

highline base units								highline corner units			
double base units						corner base units 800mm			corner base unit 900mm		
700mm	800mm	800mm sink unit (includes base liner)	900mm	900mm sink unit (includes base liner)	1000mm	1000mm sink unit (includes base liner)	300mm door	400mm door	450mm door	450mm door	
BH70	BH80	BH80S	BH90	BH90S	BH100	BH10S	BC83L/R	BC84L/R	BC845L/R	BC945L/R	
£590	£606	£652	£612	£658	£669	£715	£620	£628	£631	£631	

highline corner units					
corner base units 1000mm		corner base units 1000mm with VS CORNERSTONE MAXX pull out		corner base units 900mm with VS COR FLEX pull out	
450mm door	500mm door	600mm door	500mm door	600mm door	450mm door
BC145L/R	BC15L/R	BC16L/R	BCL15L/R	BCL16L/R	BCO945L/R
£636	£662	£684	£1,527	£1,612	£1,641

highline corner units				feature base units		
corner base units 1000mm with VS COR FLEX pull out			950L corner base unit	belfast sink unit (requires customisation)		
450mm door	500mm door	600mm door	950mm	600mm (495mm high door - for sinks up to 220mm high)	600mm (450mm high door - for sinks up to 265mm high)	800mm (495mm high doors - for sinks up to 220mm high)
BCO145L/R	BCO15L/R	BCO16L/R	BCL9	BSU6495L/R	BSU6450L/R	BSU8495
£1,646	£1,672	£1,694	£996	£361	£351	£484

drawerline base units										
Please state which drawer type you would like upon ordering	highline drawer unit with 1 pan drawer & 2 internal drawers				single base units				double base units	
	300mm	400mm	500mm	600mm	300mm	400mm	500mm	600mm	800mm	1000mm
Excel	£732	£783	£855	£917	£482	£533	£584	£594	£962	£1,041
Legrabox	£1,072	£1,123	£1,195	£1,257	£582	£633	£684	£694	£1,162	£1,241
Oak	£1,102	£1,153	£1,225	£1,287	£592	£643	£694	£704	£1,182	£1,261

Please state which drawer type you would like upon ordering	drawerline base units			drawerline corner units				
	double base units (1 drawer + 2 door)			corner base unit 800mm			corner base units 1000mm	
	800mm	900mm	1000mm	300mm door/drw	400mm door/drw	500mm door/drw	500mm door/drw	600mm door/drw
BDL81DW	BDL91DW	BDL101DW	BDLC83L/R	BDLC84L/R	BDLC85L/R	BDLC15L/R	BDLC16L/R	
Excel	£839	£886	£933	£759	£806	£843	£848	£838
Legrabox	£939	£986	£1,033	£859	£906	£943	£948	£938
Oak	£949	£996	£1,043	£869	£916	£953	£958	£948

drawer base units															
Please state which drawer type you would like upon ordering	4 drawer unit (1 pan)			3 drawer unit (2 pan)				2 drawer unit (2 pan)			2 drawer unit with internal drawer (2 pan)			low single drawer unit 360mm high	
	500mm	500mm	600mm	800mm	900mm	1000mm	600mm	800mm	900mm	1000mm	600mm	800mm	900mm	1000mm	600mm
BD54	BD53	BD63	BD83	BD93	BD13	BD62	BD82	BD92	BD12	BD62I	BD82I	BD92I	BD12I	BD635L	
Excel	£1,006	£869	£925	£1,017	£1,062	£1,114	£797	£866	£968	£992	£973	£1,059	£1,169	£1,198	£441
Legrabox	£1,446	£1,249	£1,305	£1,397	£1,442	£1,494	£1,077	£1,146	£1,248	£1,272	£1,353	£1,439	£1,549	£1,578	£581
Oak	£1,486	£1,279	£1,335	£1,427	£1,472	£1,524	£1,097	£1,166	£1,268	£1,292	£1,383	£1,469	£1,579	£1,608	£591

wall units (575mm, 720mm & 900mm high)													
Please state which drawer type you would like upon ordering	single wall units						double wall units				standard corner units		
	300mm	350mm	400mm	450mm	500mm	600mm	700mm	800mm	900mm	1000mm	600mm	900mm	
575mm high	W357L/R	W457L/R	W4557L/R	W557L/R	W657L/R	W857	W957	W157	WC657L/R	WC957L/R			
	£291	£331	£349	£370	£367	£581	£603	£642	£441	£510			
720mm high	W30L/R	W35L/R	W40L/R	W45L/R	W50L/R	W60L/R	W70	W80	W90	W100	WC6L/R	WC9L/R	
	£325	£328	£341	£349	£381	£411	£585	£601	£603	£664	£475	£554	
900mm high	TW30L/R	TW40L/R	TW45L/R	TW50L/R	TW60L/R	TW80	TW90	TW100	TWC6L/R	TWC9L/R			
	£395	£412	£417	£448	£451	£706	£708	£760	£563	£608			

wall units (720mm high)						feature wall units					
'L' shaped wall units	bi-fold units			glass wall unit (oak & walnut cab only)		smoked glass wall unit		reeded glass wall unit (glass is clear, not smoked)		microwave wall unit	boiler unit 900mm high
650mm	600mm	800mm	900mm	1000mm	500mm	500mm	600mm	500mm	600mm	600mm	600mm door
WCL65	WB160	WB180	WB190	WB110	WG5-L/R	WGS5	WGS6	WGR5	WGR6	WM60	WBHUL/R
£781	£777	£877	£967	£994	£517	£434	£476	£434	£476	£511	£421

bridging units									
bridging units 285mm high (with Blum Aventos HK-S)					bridging units 360mm high (with Blum Aventos HK-S)				
600mm	800mm	900mm	1000mm	600mm	800mm	900mm	1000mm		
WB62	WB82	WB92	WB12	WB63	WB83	WB93	WB13		
£348	£446	£460	£483	£380	£443	£498	£512		

+ Belfast sink cabinets are the correct height for a 495mm door, if a 450mm door is being used then the cabinet must be trimmed at the bottom. We also recommend you order door coloured material for the sink to sit on with the 495 door unit so that the cabinet is not visible around the edges of the sink.

IMPORTANT: Profile & Faversham doors are handed by the side they are hinged to the cabinet and are drilled to order. Please specify either L or R at the end of your unit code when ordering. For hinge drilling, all doors are treated as base doors, so if you order a LH hinged wall unit, the code on the door packaging will be RH as the door is rotated upside down, so the integrated handle is at the bottom.

†† Unit supplied as standard with solid shelves, glass shelves extra. 500mm & 600mm glass shelf (8mm) £70 each.

▲ This unit is made using a 330mm deep cabinet and requires the holes for the legs and drawer runners to be drilled on site.

Prices include soft close doors and drawers as standard (LochAnna Excel drawers).

appliance housings - Note: see page 136 for full housing door configurations

	50/50 fridge freezer housing	70/30 fridge freezer housing	If ordering a housing with drawer, please state which drawer type you would like	double oven housing	double oven housing 2 drawer	double oven / micro housing 1 drawer	single oven housing	single oven housing 1 drawer
	600mm	600mm		600mm	600mm	600mm	600mm	600mm
	AH-F55	AH-F73L/R		AH-DOL/R	AH-DO2DL/R	AH-DMW	AH-SOL/R	AH-SO1DL/R
Standard height 1968mm	£1,043	£1,043	Excel Legrabox Oak	£886	£1,218 £1,498 £1,518	£1,119 £1,259 £1,269	£1,025	£1,128 £1,228 £1,238
Extra Tall 2148mm	TAH-F55L/R	TAH-F73L/R	Excel Legrabox Oak	TAH-DOL/R	TAH-DO2DL/R		TAH-SO	
	£1,109	£1,268		£1,098	£1,367 £1,647 £1,667		£1,123	

	If ordering a housing with drawer, please state which drawer type you would like	single oven housing 2 drawer	single oven housing 3 drawer	single oven / micro housing	single oven / micro housing 2 drawers	twin single oven housing	compact oven / microwave housing
		600mm	600mm	600mm	600mm	600mm	600mm
		AH-SO2DL/R	AH-SO3DL/R	AH-SMW	AH-SM2DL/R	AH-SOTL/R	AH-CO
Standard height 1968mm	Excel Legrabox Oak	£1,332 £1,612 £1,632	£1,486 £1,866 £1,896	£961	£1,258 £1,498 £1,518	£1,025 £1,165 £1,175	£1,104
Extra Tall 2148mm	Excel Legrabox Oak	TAH-SO2DL/R		TAH-SMWL/R		TAH-SOTL/R	TAH-COL/R
		£1,481 £1,761 £1,781		£1,035		£860	£1,234

built under housings	
600 built under oven housing (drawer cannot be upgraded)	
fixed panel	with drawer
BOH6	BOHD6
£238	£351

over counter corner housings			
If ordering a housing with drawer, please state which drawer type you would like	single oven housing	compact appliance / microwave housing	storage unit
	600mm	600mm	600mm
	CH-SOL/R	CH-MWL/R	CH-STL/R
Excel Legrabox Oak	£765	£846 £946 £956	£1,108 £1,208 £1,218
	TCH-SOL/R	TCH-MWL/R	TCH-STL/R
Excel Legrabox Oak	£996	£976	£1,203

larders							
	larder unit 2 door				larder unit with VS TAL Larder pull out		
	300mm	400mm	500mm	600mm	300mm	400mm	
	L3L/R	L4L/R	L5L/R	L6L/R	LP3	LP4	
Standard height 1968mm	£869	£922	£991	£1,126	£1,656	£1,833	
Extra Tall 2148mm	TL3L/R	TL4L/R	TL5L/R	TL6L/R	TLP3	TLP4	
	£925	£977	£1,042	£1,149	£1,712	£1,888	

	larder unit with pull out oak dovetail drawers				larder drawer tower with excel plus glass drawers (supplied with 155° hinges) Note: this requires the 1245mm door to be fitted at the bottom			larder unit with VS TAL Gate Pro pull out		larder unit with VS TAL Gate pull out		diagonal corner larder 1016 x 1016mm
	300mm	400mm	500mm	600mm	300mm	500mm	600mm	500mm	600mm	500mm	600mm	600mm door
	LPOD3	LPOD4	LPOD5	LPOD6	LT3L/R	LT5L/R	LP6TL/R	LP5TL/R	LP6TL/R	LP5TSL/R	LP6TSL/R	LACL/R
Standard 1968mm	£1,949	£2,042	£2,111	£2,251	£1,970	£2,160	£2,312	£2,074	£2,312	£1,925	£2,113	£2,416
Extra Tall 2148mm	TLPOD3	TLPOD4	TLPOD5	TLPOD6	TLT3L/R	TLT5L/R	TLT6L/R	TLP5TL/R	TLP6TL/R	TLP5TSL/R	TLP6TSL/R	TLACL/R
	£2,005	£2,097	£2,162	£2,274	£2,026	£2,211	£2,384	£2,296	£2,335	£2,038	£2,136	£2,798

	1000mm butler's pantry oak & walnut cab only		The extra tall 1000mm larders have an additional top box which needs to be affixed to the top of the standard height unit to make it extra tall. If ordering a larder with drawer, please state which drawer type you would like	larder unit 4 doors	larder unit 4 doors 1 drawer	larder unit 2 doors 3 drawers	larder unit 2 doors 2 drawers	1000mm blind corner larder*		1000mm blind corner larder with VS CORNERSTONE MAXX pull out LH / RH (LH Shown)	
	1000mm	1000mm		1000mm	1000mm	1000mm	1000mm	500mm door	600mm door	500mm door	600mm door
	LBP10			LPN14D	LPN14D1DW	LPN12D3DW	LPN12D2DW	LBC15L/R	LBC16L/R	LBCLM15L/R	LBCLM16L/R
Standard height 1968mm	£2,677	£3,057	Excel Legrabox Oak	£1,660	£1,911 £2,011 £2,021	£2,098 £2,478 £2,276	£1,976 £2,256 £2,508	£1,290	£1,380	£3,128	£3,344
Extra Tall 2148mm	TLBP10			TLPN14D				TLBC15L/R	TLBC16L/R	TLBCLM15L/R	TLBCLM16L/R
	£2,814			£1,861				£1,459	£1,521	£3,297	£3,485

Full height larder doors available in Profile only, standard height larders only * If installing alongside base units you must order a tall plant on panel. See page 141 for technical information.

lifestyle larders

	easy access larder	cleaning & utility larder	cleaning & utility larder	cleaning & utility larder - extra shelves	combi larder (this unit comes as standard with full height space in the centre, storage cubes can be added as optional extra)	laundry stacker larder
	600mm	600mm	1000mm	1000mm	1000mm	800mm
	LL6EAL/R	LL6CUL/R	LL10CU	LL10CUS	LL10CB	LL8LS
Standard height 1968mm	£1,168	£1,118	£1,771	£1,870	£1,781	£1,830
Extra Tall 2148mm	TLL6EAL/R	TLL6CUL/R	TLL10CU	TLL10CUS	TLL10CB	TLL8LS
	£1,267	£1,217	£1,972	£2,071	£1,982	£2,039

integrated appliance fascias					profile plain panels		faversham plain panels						
integrated extractor door	built under fridge / dw / washer door	integrated dishwasher door	semi integrated dishwasher door	boiler door	wall plant on panel	end support panel	feature end support panel	tall plant on panel	large universal panel / breakfast bar back panel	small breakfast bar back panel			
450 x 600mm	715 x 600mm	715 x 450mm	570 x 600mm	895 x 600mm	960 x 360mm	900 x 650mm	900 x 650mm	2430 x 650mm	910 x 2450mm	900 x 1200mm			
AD60ICH	AD60FD	AD45I	AD60S	BLD9L/R	PWEP9	ESP	BIFP	PTEP2	LUP	BBP			
£163	£252	£204	£208	£272	£188	£188	£361	£480	£383	£624	£487	£314	£244

T&G panels (Faversham only)					accessories / trims					
wall plant on panel	end support panel	tall plant on panel	large universal panel / breakfast bar back panel	small breakfast bar back panel	open wall unit	wine rack	mantle shelf	plate rack (oak only)	wine rack rail (oak only)	
960 x 360mm	900 x 650mm	2430 x 650mm	910 x 2450mm	900 x 1200mm	500mm	150mm	1752 x 130 x 170mm	1200 x 336 x 23mm to be cut to size	1200 x 63mm to be cut to size	
PWEP9-TG	ESP-TG	PTEP2-TG	LUP-TG	BBP-TG	57OU	WR72	MTS17	PRK	WRK	
£241	£241	£552	£595	£300	£188	£200	£696	£240	£73	

accessories / trims												
modular pilaster	modular pilaster bead	optional corner unit adjustment filler panel	plinth	stepped skirting plinth	under plinth	feature plinth	traditional cornice	angled cornice	universal cornice / pelmet	modern pelmet		
900 x 75mm	2400 x 75mm	900 x 75mm	715 x 147mm	3050 x 150mm	2450 x 150mm	3000 x 60mm	2500 x 150 x 9mm	3050 x 81 x 65mm	3050 x 65 x 41mm	3000 x 28 x 50mm	3050 x 60 x 35mm	
MP900	MP2400	MPBD	CKP	PL	SKPL	UDPL	FTPL	SCCRN	ACRN	SQPEL	CORPEL	
£196	£373	£70	£101	£168	£357	£168	£168	£153	£148	£148	£148	

accessories / trims												
traditional pelmet	external corner post	base internal corner post	wall internal corner post	tall feature end post	curved end post	traditional cornice curved end post cap	angled cornice curved end post cap	curved end post base cap	edging tape roll (veneered)	touch up paint	care kit	touch up paint 1L tin
3050 x 29 x 55mm	930 x 90 x 70mm	715 x 80 x 80mm	715 x 60 x 60mm	3050 x 60 x 35mm	2450 x 50 x 70mm	92 x 92 x 65mm	111 x 111 x 41mm	150 x 64 x 64mm	oak (10m)	20ml		1 Litre
SCPEL	EXCP	LBF	LWF	FEP	CVP	CPBT	ACPBT	CVEBC	ET	TUP	CK	TUP-1L
£148	£385	£212	£107	£136	£167	£137	£109	£279	£35	£46	£81	£136

grain direction See pages 10-11 for cabinet colour supplied as standard. Please specify cabinet colour when ordering. See page 10-11 for lead times.

Important: Profile and Faversham doors are handled by the side they hinge to the cabinet and are drilled to order, please specify either L or R at the end of your unit code when ordering. For hinge drilling, all doors are treated as base doors, so if you order a LH hinged wall unit, the code on the door packaging will be RH as the door is rotated upside down so the integrated handle is at the bottom. For tall units with 2 doors, the unit is handed by the bottom door. On 1245/715 splits, we assume the 715 door is at the bottom (apart from larder towers, which need to have the 1245 door at the bottom).

Touch up paints and care kits should only be used for minor repairs to backs and edges of doors. They should not be used on door fronts

Prices include soft close doors and drawers as standard (LochAnna Excel drawers). Handles must be purchased separately.

highline base units																
base unit with VS SUB pull out		single base units						single base units with pull-out waste bin (door is mounted to the bin - see page 117 for full details)								
150mm trays	300mm trays	150mm	300mm	350mm	400mm	450mm	500mm	500mm sink unit (includes base liner)	600mm	600mm sink unit (includes base liner)	300mm + bin (35L-1x35L)	400mm + bin (64L-2x32L)	450mm + bin (70L-2x35L)	500mm + bin (70L-2x35L)	600mm + bin (86L-4xbins)	600mm + bin (80L-2x40L)
BP15TY	BP3TY	BH15	BH30	BH35	BH40	BH45	BH50	BH50S	BH60	BH60S	BH3B	BH4B	BH45B	BH5B	BH6B4	BH6B2
£471	£738	£291	£343	£346	£355	£369	£398	£428	£440	£486	£711	£788	£807	£842	£973	£921

highline base units							highline corner units			
double base units							corner base units 800mm			corner base unit 900mm
700mm	800mm	800mm sink unit (includes base liner)	900mm	900mm sink unit (includes base liner)	1000mm	1000mm sink unit (includes base liner)	300mm door	400mm door	450mm door	450mm door
BH70	BH80	BH80S	BH90	BH90S	BH100	BH105	BC83	BC84	BC84S	BC94S
£590	£606	£652	£612	£658	£669	£715	£620	£628	£631	£631

highline corner units					
corner base units 1000mm		corner base units 1000mm with VS CORNERSTONE MAXX pull out		corner base units 900mm with VS COR FLEX pull out	
450mm door	500mm door	600mm door	500mm door	600mm door	450mm door
BC14S	BC15	BC16	BCL15L/R	BCL16L/R	BCO94S
£636	£662	£684	£1,420	£1,505	£1,534

highline corner units				feature base units		
corner base units 1000mm with VS COR FLEX pull out		950L corner base unit	belfast sink unit (requires customisation)			
450mm door	500mm door	600mm door	950mm	600mm (495mm high door - for sinks up to 220mm high)	600mm (450mm high door - for sinks up to 265mm high)	800mm (495mm high doors - for sinks up to 220mm high)
BCO14S	BCO15	BCO16	BCL9	BSU649S	BSU6450	BSU849S
£1,539	£1,565	£1,587	£881	£361	£351	£484

drawerline base units										
Please state which drawer type you would like upon ordering	highline drawer unit with 1 pan drawer & 2 internal drawers				single base units				double base units	
	300mm	400mm	500mm	600mm	300mm	400mm	500mm	600mm	800mm	1000mm
Excel	BHD3	BHD4	BHD5	BHD6	BDL3	BDL4	BDL5	BDL6	BDL8	BDL10
£732	£783	£855	£917	£482	£533	£584	£594	£962	£1,041	
Legrabox	£1,072	£1,123	£1,195	£1,257	£582	£633	£684	£694	£1,162	£1,241
Oak	£1,102	£1,153	£1,225	£1,287	£592	£643	£694	£704	£1,182	£1,261

drawerline base units				drawerline corner units							
double base units (1 drawer + 2 door)				corner base unit 800mm			corner base units 1000mm				
800mm	900mm	1000mm		300mm door/drw	400mm door/drw	500mm door/drw	500mm door/drw	600mm door/drw			
Please state which drawer type you would like upon ordering				BDL81DW	BDL91DW	BDL101DW	BDLC83	BDLC84	BDLC85	BDLC15	BDLC16
Excel	£839	£886	£933	£759	£806	£843	£848	£838			
Legrabox	£939	£986	£1,033	£859	£906	£943	£948	£938			
Oak	£949	£996	£1,043	£869	£916	£953	£958	£948			

drawer base units															
4 drawer unit (1 pan)	3 drawer unit (2 pan)					2 drawer unit (2 pan)				2 drawer unit with internal drawer (2 pan)		low single drawer unit 360mm high			
500mm	500mm	600mm	800mm	900mm	1000mm	600mm	800mm	900mm	1000mm	600mm	800mm	900mm	1000mm	600mm	
Please state which drawer type you would like upon ordering															
BD54	BD53	BD63	BD83	BD93	BD13	BD62	BD82	BD92	BD12	BD62I	BD82I	BD92I	BD12I	BD635L	
Excel	£1,006	£869	£925	£1,017	£1,062	£1,114	£797	£866	£968	£992	£973	£1,059	£1,169	£1,198	£441
Legrabox	£1,446	£1,249	£1,305	£1,397	£1,442	£1,494	£1,077	£1,146	£1,248	£1,272	£1,353	£1,439	£1,549	£1,578	£581
Oak	£1,486	£1,279	£1,335	£1,427	£1,472	£1,524	£1,097	£1,166	£1,268	£1,292	£1,383	£1,469	£1,579	£1,608	£591

wall units (575mm, 720mm & 900mm high)												
single wall units						double wall units				standard corner units		
300mm	350mm	400mm	450mm	500mm	600mm	700mm	800mm	900mm	1000mm	600mm	900mm	
575mm high	W357		W457	W4557	W557	W657		W857	W957	W157	WC657	WC957
	£291		£331	£349	£370	£367		£581	£603	£642	£473	£542
720mm high	W30	W35	W40	W45	W50	W60	W70	W80	W90	W100	WC6	WC9
	£325	£328	£341	£349	£381	£411	£585	£601	£603	£664	£475	£554
900mm high	TW30		TW40	TW45	TW50	TW60		TW80	TW90	TW100	TWC6	TWC9
	£395		£412	£417	£448	£451		£706	£708	£760	£563	£608

wall units (720mm high)					feature wall units							
'L' shaped wall units	bi-fold units				glass wall unit	glass dresser unit	1000mm wide 2 door breakfast dresser 400mm deep cabinet				microwave wall unit	boiler unit 900mm high
	600mm	800mm	900mm	1000mm	500mm	500mm	1210mm high (40mm w/top)	1220mm high (30mm w/top)	1225mm high (25mm w/top)	1230mm high (20mm w/top)	600mm	600mm door
WCL65	WBI60	WBI80	WBI90	WBI10	WG5	WDR50	WDB100	WDB1001	WDB1002	WDB1003	W60	WBHU
£718	£777	£877	£967	£994	£517	£1,086	£1,831	£1,831	£1,831	£1,831	£411	£421

bridging units											
bridging units 285mm high (with Blum Aventos HK-S)						bridging units 360mm high (with Blum Aventos HK-S)					
600mm	800mm	900mm	1000mm	600mm	800mm	900mm	1000mm				
WB62	WB82	WB92	WB12	WB63	WB83	WB93	WB13				
£348	£446	£460	£483	£380	£443	£498	£512				

†† Unit supplied as standard with solid shelves, glass shelves extra. 500mm & 600mm glass shelf (8mm) £70 each.

▲ This unit is made using a 330mm deep cabinet and requires the holes for the legs and drawer runners to be drilled on site.

+ Belfast sink cabinets are the correct height for a 495mm door, if a 450mm door is being used then the cabinet must be trimmed at the bottom. We also recommend you order door coloured material for the sink to sit on with the 495 door unit so that the cabinet is not visible around the edges of the sink.

Prices include soft close doors and drawers as standard (LochAnna Excel drawers). Handles must be purchased separately.

appliance housings - Note: see page 136 for full housing door configurations

	50/50 fridge freezer housing	70/30 fridge freezer housing	If ordering a housing with drawer, please state which drawer type you would like	double oven housing	double oven housing 2 drawer	double oven / micro housing 1 drawer	single oven housing	single oven housing 1 drawer
	600mm	600mm		600mm	600mm	600mm	600mm	600mm
	AH-F55	AH-F73		AH-DO	AH-DO2D	AH-DMW	AH-SO	AH-SO1D
Standard height 1968mm	£1,043	£1,043	Excel Legrabox Oak	£886	£1,218 £1,498 £1,518	£1,119 £1,259 £1,269	£1,025	£1,128 £1,228 £1,238
Extra Tall 2148mm	TAH-F55 £1,109	TAH-F73 £1,153	Excel Legrabox Oak	TAH-DO £1,098	TAH-DO2D £1,367 £1,647 £1,667		TAH-SO £1,123	

	If ordering a housing with drawer, please state which drawer type you would like	single oven housing 2 drawer	single oven housing 3 drawer	single oven / micro housing	single oven / micro housing 2 drawers	twin single oven housing	compact oven / microwave housing
		600mm	600mm	600mm	600mm	600mm	600mm
		AH-SO2D	AH-SO3D	AH-SMW	AH-SM2D	AH-SOT	AH-CO
Standard height 1968mm	Excel Legrabox Oak	£1,332 £1,612 £1,632	£1,486 £1,866 £1,896	£961	£1,258 £1,498 £1,518	£1,025 £1,165 £1,175	£1,104
Extra Tall 2148mm	Excel Legrabox Oak	TAH-SO2D £1,481 £1,761 £1,781		TAH-SMW £1,035		TAH-SOT £860	TAH-CO £1,124

built under housings	
600 built under oven housing (drawer cannot be upgraded)	
fixed panel	with drawer
BOH6 £238	BOHD6 £351

over counter corner housings			
If ordering a housing with drawer, please state which drawer type you would like	single oven housing	compact appliance / microwave housing	storage unit
	600mm	600mm	600mm
	CH-SO	CH-MW	CH-ST
Excel Legrabox Oak	£765	£846 £946 £956	£1,108 £1,208 £1,218
	TCH-SO	TCH-MW	TCH-ST
Excel Legrabox Oak	£976 £1,096 £1,106	£996	£1,203 £1,303 £1,313

larders							
	larder unit 2 door				larder unit with VS TAL Larder pull out		
	300mm	400mm	500mm	600mm	300mm	400mm	
	L3	L4	L5	L6	LP3	LP4	
Standard height 1968mm	£869	£922	£991	£1,126	£1,656	£1,833	
Extra Tall 2148mm	TL3	TL4	TL5	TL6	TLP3	TLP4	
	£925	£977	£1,042	£1,149	£1,712	£1,888	

	larder unit with pull out oak dovetail drawers				larder drawer tower with excel plus glass drawers (supplied with 155° hinges) Note: this requires the 1245mm door to be fitted at the bottom			larder unit with VS TAL Gate Pro pull out		larder unit with VS TAL Gate pull out		diagonal corner larder 1016 x 1016mm
	300mm	400mm	500mm	600mm	300mm	500mm	600mm	500mm	600mm	500mm	600mm	600mm door
	LPD3	LPD4	LPD5	LPD6	LT3	LT5	LT6	LP5T	LP6T	LP5TS	LP6TS	LAC
Standard 1968mm	£1,949	£2,042	£2,111	£2,251	£1,970	£2,160	£2,361	£2,183	£2,312	£1,925	£2,113	£2,349
Extra Tall 2148mm	TLPOD3	TLPOD4	TLPOD5	TLPOD6	TLT3	TLT5	TLT6	TLP5T	TLP6T	TLP5TS	TLP6TS	TLAC
	£2,005	£2,097	£2,162	£2,274	£2,026	£2,211	£2,384	£2,234	£2,335	£1,976	£2,136	£2,712

	The extra tall 1000mm larders have an additional top box which needs to be affixed to the top of the standard height unit to make it extra tall. If ordering a larder with drawer, please state which drawer type you would like	1000mm butler's pantry oak & walnut cab only		larder unit 4 doors	larder unit 4 doors 1 drawer	larder unit 2 doors 3 drawers	larder unit 2 doors 2 drawers	1000mm blind corner larder*		1000mm blind corner larder with VS CORNERSTONE MAXX pull out LH / RH (LH Shown)	
		1000mm	1000mm	1000mm	1000mm	1000mm	1000mm	500mm door	600mm door	500mm door	600mm door
		LBP10	LPN14D	LPN14D1DW	LPN12D3DW	LPN12D2DW	LBC15	LBC16	LBCLM15L/R	LBCLM16L/R	
Standard height 1968mm	Excel Legrabox Oak	£2,677 £3,057 £3,490	£1,660	£1,911 £2,011 £2,021	£2,098 £2,478 £2,508	£1,976 £2,256 £2,276	£1,290	£1,380	£3,128	£3,344	
Extra Tall 2148mm	Excel Legrabox Oak	TLBP10 £2,814 £3,194 £3,627	TLPN14D £1,861				TLBC15 £1,459	TLBC16 £1,521	TLBCLM15L/R £3,297	TLBCLM16L/R £3,485	

SD Full height larder doors available 600mm wide only, standard height larders only * If installing alongside base units you must order a tall plant on panel. See page 141 for technical information.

lifestyle larders

	easy access larder	cleaning & utility larder	cleaning & utility larder	cleaning & utility larder - extra shelves	combi larder (this unit comes as standard with full height space in the centre, storage cubes can be added as optional extra)	laundry stacker larder
	600mm	600mm	1000mm	1000mm	1000mm	800mm
	LL6EA	LL6CU	LL10CU	LL10CUS	LL10CB	LL8LS
Standard height 1968mm	£1,168	£1,118	£1,771	£1,870	£1,781	£1,830
Extra Tall 2148mm	TLL6EA £1,267	TLL6CU £1,217	TLL10CU £1,972	TLL10CUS £2,071	TLL10CB £1,982	TLL8LS £2,039

integrated appliance fascias					plain panels				
integrated extractor door	built under fridge / dw / washer door	integrated dishwasher door	semi integrated dishwasher door	boiler door	wall plant on panel	end support panel	tall plant on panel	large universal panel / breakfast bar back panel	breakfast bar back panel
450 x 600mm	715 x 600mm	715 x 450mm	570 x 600mm	895 x 600mm	960 x 360mm	900 x 650mm	2430 x 650mm	910 x 2450mm	900 x 1200mm
AD60ICH	AD60FD	AD45I	AD60S	BLD9	PWEP9	ESP	PTEP2	LUP	BBP
£163	£252	£204	£208	£272	£188	£188	£383	£487	£244

T&G panels					accessories / trims				
wall plant on panel	end support panel	tall plant on panel	large universal panel/breakfast bar back panel	breakfast bar back panel	open wall unit	wine rack	chopping boards & trays unit	working mantle	
960 x 360mm	900 x 650mm	2430 x 650mm	910 x 2450mm	900 x 1200mm	500mm	150mm	720 x 200mm	1400 x 1600 420mm	1400 x 1800 420mm
PWEP9-TG	ESP-TG	PTEP2-TG	LUP-TG	BBP-TG	570U	WR72	CBTR	WM16	WM18
£241	£241	£552	£595	£300	£188	£200	£1,530	£3,149	£3,185

accessories / trims							
mantle shelf	shelf bracket (1 no.)	plate rack (oak only)	wine rack rail (oak only)	modular pilaster (use the bead as a filler in the back of the pilaster when being used as a leg)		modular pilaster bead	optional corner unit adjustment filler panel (for use when more than 80x80 is required)
1752 x 130 x 170mm	166 x 125 x 21mm	1200 x 336 x 23mm to be cut to size	1200 x 63mm to be cut to size	900 x 75mm	2400 x 75mm	910 x 20mm	715 x 147mm
MTS17	SHB	PRK	WRK	MP900	MP2400	MPBD	CKP
£696	£120	£240	£73	£196	£373	£70	£107

accessories / trims							
plinth	stepped skirting plinth	under plinth	feature plinth	traditional cornice	angled cornice	traditional pelmet	modern pelmet
3050 x 150mm	2450 x 150mm	3000 x 60mm	2500 x 150 x 9mm	3050 x 81 x 65mm	3050 x 65 x 41mm	3050 x 29 x 55mm	3050 x 60 x 35mm
PL	SKPL	UDPL	FTPL	SCCRN	ACRN	SCPEL	CORPEL
£168	£357	£168	£168	£153	£148	£148	£148

accessories / trims								
tall feature end post	curved end post	traditional cornice curved end post cap	angled cornice curved end post cap	curved end post base cap	edging tape roll (veneered)	touch up paint	care kit	touch up paint 1L tin
3050 x 60 x 35mm	2450 x 50 x 70mm	92 x 92 x 65mm	111 x 111 x 41mm	150 x 64 x 64mm	oak (10m) unfinished	20ml	includes pen, soft wax & applicator, scotchbrite pad	1 litre
FEP	CVP	CPBT	ACPBT	CVEBC	ET	TUP	CK	TUP-1L
£136	£167	£137	£109	£279	£35	£46	£81	£136

See pages 10-11 for cabinet colour supplied as standard. Please specify cabinet colour when ordering. Handle options - see pages 80-86. See page 10-11 for lead times.

Prices include soft close doors and drawers as standard (LochAnna Excel drawers). Handles must be purchased separately.

highline base units																
base unit with VS SUB pull out		single base units						single base units with pull-out waste bin (door is mounted to the bin - see page 117 for full details)								
150mm trays	300mm trays	150mm	300mm	350mm	400mm	450mm	500mm	500mm sink unit (includes base liner)	600mm	600mm sink unit (includes base liner)	300mm + bin (35L-1x35L)	400mm + bin (64L-2x32L)	450mm + bin (70L-2x35L)	500mm + bin (70L-2x35L)	600mm + bin (86L-4xbins)	600mm + bin (80L-2x40L)
BP15TY	BP3TY	BH15	BH30	BH35	BH40	BH45	BH50	BH50S	BH60	BH60S	BH3B	BH4B	BH45B	BH5B	BH6B4	BH6B2
£471	£738	£291	£343	£346	£355	£369	£398	£428	£440	£486	£711	£788	£807	£842	£973	£921

highline base units							highline corner units				
double base units					corner base units 800mm			corner base unit 900mm			
700mm	800mm	800mm sink unit (includes base liner)	900mm	900mm sink unit (includes base liner)	1000mm	1000mm sink unit (includes base liner)	300mm door	400mm door	450mm door	450mm door	
BH70	BH80	BH80S	BH90	BH90S	BH100	BH105	BC83	BC84	BC84S	BC94S	
£590	£606	£652	£612	£658	£669	£715	£620	£628	£631	£631	

highline corner units					
corner base units 1000mm		corner base units 1000mm with VS CORNERSTONE MAXX pull out		corner base units 900mm with VS COR FLEX pull out	
450mm door	500mm door	600mm door	500mm door	600mm door	450mm door
BC14S	BC15	BC16	BCL15L/R	BCL16L/R	BCO94S
£636	£662	£684	£1,420	£1,505	£1,534

highline corner units			feature base units			
corner base units 1000mm with VS COR FLEX pull out		950L corner base unit	belfast sink unit (requires customisation)			
450mm door	500mm door	600mm door	950mm	600mm (495mm high door - for sinks up to 220mm high)	600mm (450mm high door - for sinks up to 265mm high)	800mm (495mm high doors - for sinks up to 220mm high)
BCO14S	BCO15	BCO16	BCL9	BSU649S	BSU6450	BSU849S
£1,539	£1,565	£1,587	£881	£361	£351	£457

drawerline base units										
Please state which drawer type you would like upon ordering	highline drawer unit with 1 pan drawer & 2 internal drawers				single base units				double base units	
	300mm	400mm	500mm	600mm	300mm	400mm	500mm	600mm	800mm	1000mm
Excel	BHD3	BHD4	BHD5	BHD6	BDL3	BDL4	BDL5	BDL6	BDL8	BDL10
£732	£783	£855	£917	£482	£533	£584	£594	£962	£1,041	
Legrabox	£1,072	£1,123	£1,195	£1,257	£582	£633	£684	£694	£1,162	£1,241
Oak	£1,102	£1,153	£1,225	£1,287	£592	£643	£694	£704	£1,182	£1,261

drawerline base units						drawerline corner units				
Please state which drawer type you would like upon ordering	double base units (1 drawer + 2 door)			corner base unit 800mm			corner base units 1000mm			
	800mm	900mm	1000mm	300mm door/drw	400mm door/drw	500mm door/drw	500mm door/drw	600mm door/drw		
Excel	BDL81DW	BDL91DW	BDL101DW	BDLC83	BDLC84	BDLC85	BDLC15	BDLC16		
£837	£884	£931	£759	£806	£843	£848	£938			
Legrabox	£937	£984	£1,031	£859	£906	£943	£948	£938		
Oak	£947	£994	£1,041	£869	£916	£953	£958	£948		

drawer base units															
Please state which drawer type you would like upon ordering	4 drawer unit (1 pan)	3 drawer unit (2 pan)					2 drawer unit (2 pan)				2 drawer unit with internal drawer (2 pan)		low single drawer unit 360mm high		
	500mm	500mm	600mm	800mm	900mm	1000mm	600mm	800mm	900mm	1000mm	600mm	800mm	900mm	1000mm	600mm
Excel	BD54	BD53	BD63	BD83	BD93	BD13	BD62	BD82	BD92	BD12	BD62I	BD82I	BD92I	BD12I	BD635L
£1,006	£869	£925	£1,017	£1,062	£1,114	£797	£866	£968	£992	£973	£1,059	£1,169	£1,198	£441	
Legrabox	£1,446	£1,249	£1,305	£1,397	£1,442	£1,494	£1,077	£1,146	£1,248	£1,272	£1,353	£1,439	£1,549	£1,578	£581
Oak	£1,486	£1,279	£1,335	£1,427	£1,472	£1,524	£1,097	£1,166	£1,268	£1,292	£1,383	£1,469	£1,579	£1,608	£591

wall units (575mm, 720mm & 900mm high)													
	single wall units					double wall units				standard corner units			
	300mm	350mm	400mm	450mm	500mm	600mm	700mm	800mm	900mm	1000mm	600mm	900mm	
575mm high	W357		W457	W4557	W557	W657		W857	W957	W157	WC657	WC957	
	£291		£331	£349	£370	£367		£581	£603	£642	£473	£542	
720mm high	W30	W35	W40	W45	W50	W60	W70	W80	W90	W100	WC6	WC9	
	£325	£328	£341	£349	£381	£411	£585	£601	£603	£664	£475	£554	
900mm high	TW30		TW40	TW45	TW50	TW60		TW80	TW90	TW100	TWC6	TWC9	
	£395		£412	£417	£448	£451		£706	£708	£760	£563	£608	

wall units (720mm high)						feature wall units					
'L' shaped wall units	bi-fold units				glass wall unit (oak & walnut cab only)	1000mm wide 2 door breakfast dresser 400mm deep cabinet (oak & walnut cab only)				microwave wall unit	boiler unit 900mm high
650mm	600mm	800mm	900mm	1000mm	500mm	1210mm high (40mm w/top)	1220mm high (30mm w/top)	1225mm high (25mm w/top)	1230mm high (20mm w/top)	600mm	600mm door
WCL65	WBI60	WBI80	WBI90	WBI10	WGS	WDB100	WDB1001	WDB1002	WDB1003	WM60	WBHU
£718	£777	£877	£967	£994	£517	£1,831	£1,831	£1,831	£1,831	£511	£421

bridging units											
bridging units 285mm high (with Blum Aventos HK-S)						bridging units 360mm high (with Blum Aventos HK-S)					
600mm	800mm	900mm	1000mm	600mm	800mm	900mm	1000mm				
WB62	WB82	WB92	WB12	WB63	WB83	WB93	WB13				
£348	£446	£460	£483	£380	£443	£498	£512				

+ Belfast sink cabinets are the correct height for a 495mm door, if a 450mm door is being used then the cabinet must be trimmed at the bottom. We also recommend you order door coloured material for the sink to sit on with the 495 door unit so that the cabinet is not visible around the edges of the sink.

†† Unit supplied as standard with solid shelves, glass shelves extra. 500mm & 600mm glass shelf (8mm) £70 each.

▲ This unit is made using a 330mm deep cabinet and requires the holes for the legs and drawer runners to be drilled on site.

Prices include soft close doors and drawers as standard (LochAnna Excel drawers). Handles must be purchased separately.

appliance housings - Note: see page 136 for full housing door configurations

	50/50 fridge freezer housing	70/30 fridge freezer housing	If ordering a housing with drawer, please state which drawer type you would like	double oven housing	double oven housing 2 drawer	double oven / micro housing 1 drawer	single oven housing	single oven housing 1 drawer
	600mm	600mm		600mm	600mm	600mm	600mm	600mm
Standard height 1968mm	AH-F55	AH-F73	Excel Legrabox Oak	AH-DO	AH-DO2D	AH-DMW	AH-SO	AH-SO1D
	£1,043	£1,043		£886	£1,218 £1,498 £1,518	£1,119 £1,259 £1,269	£1,025	£1,128 £1,228 £1,238
	TAH-F55	TAH-F73		TAH-DO	TAH-DO2D	TAH-SO	£1,123	£1,123
£1,091	£1,136	£1,098	£1,367 £1,647 £1,667					

	If ordering a housing with drawer, please state which drawer type you would like	single oven housing 2 drawer	single oven housing 3 drawer	single oven / micro housing	single oven / micro housing 2 drawers	twin single oven housing	compact oven / microwave housing
		600mm	600mm	600mm	600mm	600mm	600mm
Standard height 1968mm	Excel Legrabox Oak	AH-SO2D	AH-SO3D	AH-SMW	AH-SM2D	AH-SOT	AH-CO
		£1,332	£1,486	£961	£1,258	£1,025	£1,104
		£1,612	£1,866		£1,498	£1,165	
£1,632	£1,896	£1,175					
Extra Tall 2148mm	Excel Legrabox Oak	TAH-SO2D	TAH-SMW	£1,035	TAH-SOT	TAH-CO	£1,124
		£1,481					
		£1,761					

built under housings

600 built under oven housing (drawer cannot be upgraded)

fixed panel	with drawer
BOH6	BOHD6
£238	£351

over counter corner housings

If ordering a housing with drawer, please state which drawer type you would like

single oven housing	compact appliance / microwave housing	storage unit
600mm	600mm	600mm
CH-SO	CH-MW	CH-ST
£765	£846	£1,108
	£946	£1,208
	£956	£1,218
TCH-SO	TCH-MW	TCH-ST
£996	£976	£1,203
£1,096		£1,243
£1,106		£1,253

larders

	larder unit 2 door				larder unit with VS TAL Larder pull out	
	300mm	400mm	500mm	600mm	300mm	400mm
Standard height 1968mm	L3	L4	L5	L6	LP3	LP4
	£869	£922	£991	£1,126	£1,656	£1,833
Extra Tall 2148mm	TL3	TL4	TL5	TL6	TLAC	TLP3
	£907	£959	£1,024	£1,131	£2,654	£1,694

larders

	larder unit with pull out oak dovetail drawers				larder drawer tower with excel plus glass drawers (supplied with 155° hinges) Note: this requires the 1245mm door to be fitted at the bottom			larder unit with VS TAL Gate Pro pull out		larder unit with VS TAL Gate pull out		diagonal corner larder 1016 x 1016mm
	300mm	400mm	500mm	600mm	300mm	500mm	600mm	500mm	600mm	500mm	600mm	600mm door
Standard 1968mm	LPOD3	LPOD4	LPOD5	LPOD6	LT3	LT5	LT6	LP5T	LP6T	LP5TS	LP6TS	LAC
	£1,949	£2,002	£2,071	£2,206	£1,970	£2,160	£2,361	£2,183	£2,312	£1,925	£2,113	£2,319
Extra Tall 2148mm	TLPD3	TLPD4	TLPD5	TLPD6	TLT3	TLT5	TLT6	TLP5T	TLP6T	TLP5TS	TLP6TS	TLAC
	£2,005	£2,097	£2,162	£2,274	£2,026	£2,211	£2,384	£2,216	£2,317	£1,958	£2,118	£2,654

larders

The extra tall 1000mm larders have an additional top box which needs to be affixed to the top of the standard height unit to make it extra tall.

If ordering a larder with drawer, please state which drawer type you would like

	1000mm butler's pantry (oak & walnut cab only)		larder unit 4 doors	larder unit 4 doors 1 drawer	larder unit 2 doors 3 drawers	larder unit 2 doors 2 drawers	1000mm blind corner larder*	
	1000mm		1000mm	1000mm	1000mm	1000mm	500mm door	600mm door
Standard height 1968mm	LBP10		LPN14D	LPN14D1DW	LPN12D3DW	LPN12D2DW	LBC15	LBC16
	£2,677		£1,660	£1,911	£2,098	£1,976	£1,290	£1,380
	£3,057			£2,011	£2,478	£2,256		
£3,490		£2,021		£2,508	£2,276			
Extra Tall 2148mm	TLBP10		TLPN14D	£1,861	£1,459	£1,521	TLBC15	TLBC16
	£2,814							
	£3,194							
	£3,627							

sd Full height larder doors available in standard height larders only. * If installing alongside base units you must order a tall plant on panel. See page 141 for technical information.

larders - Continued

1000mm blind corner larder with VS CORNERSTONE MAXX pull out LH / RH (LH Shown)

500mm door	600mm door
LBCLM15L/R	LBCLM16L/R
£3,128	£3,344
TLBCLM15L/R	TLBCLM16L/R
£3,297	£3,485

Handed by the wirework LH/RH (LH Shown)
soft close as standard

lifestyle larders

Our lifestyle larders can be customised, with different colour inner shelves & dividers & outer cabinets. They come automatically with both in the cabinet colour for the range chosen, simply indicate on your order what combination you'd like. The extra tall larders have an additional top box which needs to be affixed to the top of the standard height unit to make it extra tall.

	easy access larder	cleaning & utility larder	cleaning & utility larder	cleaning & utility larder - extra shelves	combi larder (this unit comes as standard with full height space in the centre, storage cubes can be added as optional extra)	laundry stacker larder
	600mm	600mm	1000mm	1000mm	1000mm	800mm
Standard height 1968mm	LL6EA	LL6CU	LL10CU	LL10CUS	LL10CB	LL8LS
	£1,168	£1,118	£1,771	£1,870	£1,781	£1,830
Extra Tall 2148mm	TLL6EA	TLL6CU	TLL10CU	TLL10CUS	TLL10CB	TLL8LS
	£1,267	£1,217	£1,972	£2,071	£1,982	£2,039

optional cubes available in our 6 cabinet colours: 547mm depth - £140 447mm depth - £121

integrated appliance fascias

integrated extractor door	built under fridge / dw / washer door	integrated dishwasher door	semi integrated dishwasher door	boiler door	wall plant on panel	end support panel	tall plant on panel	large universal panel / breakfast bar back panel	breakfast bar back panel
450 x 600mm	715 x 600mm	715 x 450mm	570 x 600mm	895 x 600mm	960 x 360mm	900 x 650mm	2430 x 650mm	910 x 2450mm	900 x 1200mm
AD60ICH	AD60FD	AD45I	AD60S	BLD9	PWEP9	ESP	PTEP2	LUP	BBP
£163	£252	£204	£208	£272	£188	£188	£480	£624	£314

integrated appliance fascias

integrated extractor door	built under fridge / dw / washer door	integrated dishwasher door	semi integrated dishwasher door	boiler door	wall plant on panel	end support panel	tall plant on panel	large universal panel / breakfast bar back panel	breakfast bar back panel
450 x 600mm	715 x 600mm	715 x 450mm	570 x 600mm	895 x 600mm	960 x 360mm	900 x 650mm	2430 x 650mm	910 x 2450mm	900 x 1200mm
AD60ICH	AD60FD	AD45I	AD60S	BLD9	PWEP9	ESP	PTEP2	LUP	BBP
£163	£252	£204	£208	£272	£188	£188	£480	£624	£314

stained accessories

plinth	universal cornice / pelmet	touch up stain pen	open wall unit	wine rack	mantle shelf	shelf bracket (1 no.)	plate rack (oak only)	wine rack rail (oak only)	modular pilaster	
3040 x 150 x 19mm	28 x 3000 x 50mm		500mm	150mm	1752 x 130 x 170mm	166 x 125 x 21mm	1200 x 336 x 23mm to be cut to size	1200 x 63mm to be cut to size	900 x 75mm	2400 x 75mm
PL	SQPEL	TUSP	57OU	WR72	MTS17	SHB	PRK	WRK	MP900	MP2400
£168	£148	£76	£188	£200	£696	£120	£240	£73	£196	£373

stained accessories / trims (not available in stained colours)

modular pilaster bead	optional corner unit adjustment filler panel (for use when more than 80x80 is required)	plinth	stepped skirting plinth	under plinth	feature plinth	traditional cornice	angled cornice	traditional pelmet
910 x 20mm	715 x 147mm	3050 x 150mm	2450 x 150mm	3000 x 60mm	2500 x 150 x 9mm	3050 x 81 x 65mm	3050 x 65 x 41mm	3050 x 29 x 55mm
MPBD	CKP	PL	SKPL	UDPL	FTPL	SCCRN	ACRN	SCPEL
£70	£107	£168	£357	£168	£168	£153	£148	£148

stained accessories / trims (not available in stained colours)

universal cornice / pelmet	tall feature end post	curved end post	traditional cornice curved end post cap	angled cornice curved end post cap	curved end post base cap	edging tape roll (veneered)	touch up paint	care kit	touch up paint 1L tin
28 x 3000 x 50mm	3050 x 60 x 35mm	2450 x 50 x 70mm	92 x 92 x 65mm	111 x 111 x 41mm	150 x 64 x 64mm	oak (10m) unfinished	20ml	includes pen, soft wax & applicator, scotchbrite pad	1 litre
SQPEL	FEP	CVP	CPBT	ACPBT	CVBEC	ET	TUP	CK	TUP-1L
£148	£136	£167	£137	£109	£279	£35	£42	£81	£136

▲ Touch up paints and care kits should only be used for minor repairs to backs and edges of doors. They should not be used on door fronts.

Prices include soft close doors and drawers as standard (LochAnna Excel drawers). Handles must be purchased separately.

highline base units											
base unit with VS SUB pull out		single base units					single base units with pull-out waste bin (door is mounted to the bin - see page 117 for full details)				
150mm trays	300mm	300mm	400mm	450mm	500mm	600mm	300mm + bin (35L - 1x35L)	450mm + bin (70L - 2x35L)	500mm + bin (70L - 2x35L)	600mm + bin (86L - 4 x bins)	600mm + bin (80L - 2 x 40L)
BP15TY	BP3TY	BH30L/R	BH40L/R	BH45L/R	BH50SL/R	BH60L/R	BH3B	BH45B	BH5B	BH6B4	BH6B2
£541	£870	£483	£515	£543	£555	£620	£843	£984	£1,010	£1,157	£1,105

highline base units				highline corner units		
double base units		corner base units 800mm			corner base unit 900mm	
800mm	900mm	1000mm	300mm door	400mm door	450mm door	450mm door
BH80	BH90	BH100	BC83L/R	BC84L/R	BC845L/R	BC945L/R
£905	£938	£959	£823	£851	£868	£868

highline corner units					
corner base units 1000mm			corner base units 1000mm with VS CORNERSTONE MAXX pull out		
450mm door	500mm door	600mm door	500mm door	600mm door	
BC145L/R	BC15L/R	BC16L/R	BCL15L/R	BCL16L/R	
£873	£882	£927	£1562	£1,865	

highline corner units			feature base units			
corner base units 1000mm with VS COR FLEX pull out		950L corner base unit	curved end base unit	belfast sink unit		
500mm door	600mm door	950mm	320mm	600mm (495mm high door - for sinks up to 220mm high)	600mm (450mm high door - for sinks up to 265mm high)	800mm (495mm high door - for sinks up to 220mm high)
BCO15L/R	BCO16L/R	BCL9	BHCVL/R	BSU6495L/R	BSU6450L/R	BSU8495
£1,961	£1,947	£1,325	£2,057	£576	£572	£665

drawerline base units											
Please state which drawer type you would like upon ordering	highline drawer unit with 1 pan drawer & 2 internal drawers			single base units					double base units (1 drawer + 2 door)		
	300mm	500mm	600mm	300mm	400mm	450mm	500mm	600mm	800mm	900mm	1000mm
	BHD3	BHD5	BHD6	BDL3L/R	BDL4L/R	BDL45L/R	BDL5L/R	BDL6L/R	BDL81DW	BDL91DW	BDL101DW
Excel	£864	£1,023	£1,101	£709	£753	£782	£807	£871	£1,091	£1,138	£1,183
Oak	£1,234	£1,393	£1,471	£819	£863	£892	£917	£981	£1,201	£1,248	£1,293

drawer packs										
Please state which drawer type you would like upon ordering	3 drawer unit (2 pan)					2 drawer unit (2 pan)				
	500mm	600mm	800mm	900mm	1000mm	500mm	600mm	800mm	900mm	1000mm
	BD53	BD63	BD83	BD93	BD13	BD52	BD62	BD82	BD92	BD12
Excel	£1,165	£1,255	£1,349	£1,401	£1,447	£995	£1,066	£1,172	£1,214	£1,262
Oak	£1,575	£1,665	£1,759	£1,811	£1,857	£1,295	£1,366	£1,472	£1,514	£1,562

wall units (720mm & 900mm high)										
	single wall units					double wall units			standard corner units (NOTE: door is hinged off the cabinet side)	
	300mm	400mm	450mm	500mm	600mm	800mm	900mm	1000mm	600mm	900mm
720mm high	W30L	W40L/R	W45L/R	W50L/R	W60L/R	W80	W90	W100	WC6L/R	WC9L/R
	£465	£501	£523	£538	£591	£900	£929	£954	£628	£728
900mm high	TW30L/R	TW40L/R	TW45L/R	TW50L/R	TW60L/R	TW80	TW90	TW100	TWC6L/R	TWC9L/R
	£544	£594	£617	£646	£692	£1,070	£1,108	£1,156	£763	£900

wall units (720mm high)		feature wall units							
'L' shaped wall units	boiler unit 900mm high	glass wall unit	glass dresser unit	1000mm bi-fold dresser (oak & walnut cab only)	1000mm wide 2 door breakfast dresser 400mm deep cabinet				curved end wall unit
		oak & walnut cab only			oak & walnut cab only				
650mm	600mm door	500mm	500mm	1220 x 1000 x 330mm	1210mm high (40mm w/top)	1220mm high (30mm w/top)	1225mm high (25mm w/top)	1230mm high (20mm w/top)	320mm
supplied with a 20mm bead to use as a door fillet									
WCL65	WBHUL/R	WG5L/R	WDR50	WDR100	WDB100	WDB1001	WDB1002	WDB1003	WCVL/R
£1,062	£665	£638	£1,259	£1,237	£2,245	£2,245	£2,245	£2,245	£1,834

bridging units					
bridging units 285mm high (with Blum Aventos HK-S)			bridging units 360mm high (with Blum Aventos HK-S)		
600mm	900mm	1000mm	600mm	900mm	1000mm
WB62	WB92	WB12	WB63	WB93	WB13
£924	£1,042	£1,164	£948	£1,068	£1,190

†† Unit supplied as standard with solid shelves, glass shelves extra. 500mm & 600mm glass shelf (8mm) £70 each.

Note: All Durham doors are oversized to overhang the bottom of the cabinet by 50mm. This means that no pelmet is required as the bottom frame of the door on wall units acts as pelmet.

Durham is available on oak & walnut cabinets only.

** Curved unit filler door to be trimmed on site.

▲ Note: this unit is on an 8 week lead time.

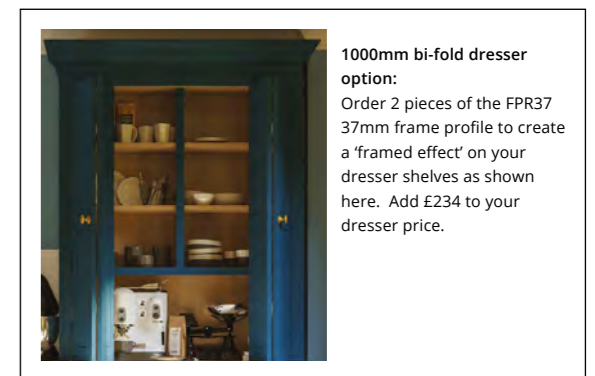

1000mm bi-fold dresser option:
Order 2 pieces of the FPR37 37mm frame profile to create a 'framed effect' on your dresser shelves as shown here. Add £234 to your dresser price.

Prices include soft close doors and drawers as standard (LochAnna Excel drawers). Handles must be purchased separately.

appliance housings - Note: see page 136 for full housing door configurations

	50/50 fridge freezer housing	70/30 fridge freezer housing	If ordering a housing with drawer, please state which drawer type you would like	double oven housing	double oven housing 2 drawer	single oven housing	single oven housing 2 drawer	single oven housing 3 drawer	single oven / micro housing	twin single oven housing	compact oven / microwave housing
	600mm	600mm		600mm	600mm	600mm	600mm	600mm	600mm	600mm	600mm
	AH-F55L/R	AH-F73L/R		AH-DOL/R	AH-DO2DL/R	AH-SOL/R	AH-SO2DL/R	AH-SO3DL/R	AH-SMWL/R	AH-SOT	AH-CO
Standard height 1970mm	£1,496	£1,526	Excel Oak	£1,255	£1,697	£1,446	£1,899	£2,081	£1,264	£2,273 £2,423	£1,501
Extra Tall 2150mm	TAH-F55L/R	TAH-F73L/R	Excel Oak	TAH-DOL/R	TAH-DO2DL/R	TAH-SOL/R	TAH-SO2DL/R	TAH-SO3DL/R	TAH-SMWL/R	TAH-SOT	TAH-COL/R
	£1,600	£1,600		£1,450	£1,874	£1,520	£1,983	£2,155	£1,423	£2,211 £2,311	£1,585

built under housings

600 built under oven housing	larder unit 2 door								larder unit with VS TAL Larder pull out		diagonal corner larder 1016 x 1016mm
	fixed panel	300mm	400mm	500mm	600mm	300mm	400mm	600mm ▲			
BOH6 £275	Standard height 1970mm	L3L/R £1,319	L4L/R £1,410	L5L/R £1,493	L6L/R £1,640	LP3 £2,091	LP4 £2,306	LACL/R £2,914			
	Extra Tall 2150mm	TL3L/R £1,384	TL4L/R £1,487	TL5L/R £1,585	TL6L/R £1,724			TLACL/R £3,297			

larders

	larder unit with pull out oak dovetail drawers				larder drawer tower with excel plus glass drawers (supplied with 155° hinges) Note: this requires the 1245mm door to be fitted at the bottom				larder unit with VS TAL Gate Pro pull out		larder unit with VS TAL Gate pull out	
	300mm	400mm	500mm	600mm	300mm	400mm	500mm	600mm	500mm	600mm	500mm	600mm
Standard height 1970mm	LPOD3 £2,384	LPOD4 £2,515	LPOD5 £2,598	LPOD6 £2,749	LT3L/R £2,405	LT4L/R £2,564	LT5L/R £2,647	LT6L/R £2,859	LP5TL/R £2,686	LP6TL/R £2,825	LP5TSL/R £2,427	LP6TSL/R £2,626
Extra Tall 2150mm			TLPOD5 £2,670	TLPOD6 £2,773			TLT5L/R £2,719	TLT6L/R £2,883	TLP5TL/R £2,757	TLP6TL/R £2,849	TLP5TSL/R £2,499	TLP6TSL/R £2,650

larders

	The extra tall 1000mm larders have an additional top box which needs to be affixed to the top of the standard height unit to make it extra tall. If ordering a larder with drawer, please state which drawer type you would like	Supplied with fixed frame doors to allow full access. If you would like framed doors please state on your order							
		1000mm butler's pantry (oak & walnut cab only)	larder unit 4 doors	larder unit 2 doors 3 drawers	larder unit 2 doors 2 drawers	1000mm blind corner larder*		1000mm blind corner larder with VS CORNERSTONE MAXX pull out	
		1000mm ▲ wicker baskets £82 (each) spice racks £630 (pair)	1000mm ▲	1000mm ▲	1000mm ▲	500mm door ▲	600mm door ▲	500mm door ▲	600mm door ▲
Standard height 1970mm	Excel £3,651	LBP10 £3,651	LPN14D £2,658	LPN12D3DW £2,996	LPN12D2DW £2,811	LBC15L/R £1,777	LBC16L/R £1,878	LBCLM15L/R £3,615	LBCLM16L/R £3,842
Extra Tall 2150mm	Oak £4,464	TLBP10 £3,830	TLPN14D £2,907			TLBC15L/R £1,967	TLBC16L/R £2,020	TLBCLM15L/R £3,805	TLBCLM16L/R £3,984

lifestyle larders

	easy access larder	cleaning & utility larder	cleaning & utility larder	cleaning & utility larder - extra shelves	combi larder (this unit comes as standard with full height space in the centre, storage cubes can be added as optional extra)	laundry stacker larder
	600mm ▲	600mm ▲	1000mm ▲	1000mm ▲	1000mm ▲	800mm ▲
Standard height 1970mm	LL6EAL/R £1,681	LL6CUL/R £1,631	LL10CU £2,775	LL10CUS £2,874	LL10CB £2,785	LL8LS £2,776
Extra Tall 2150mm	TLL6EAL/R £1,781	TLL6CUL/R £1,731	TLL10CU £3,018	TLL10CUS £3,117	TLL10CB £3,028	

SD Also available in single door - 2018mm high. Please state on your order if you want the single door. + These units are supplied as standard with 2018mm doors (1970mm height only). If you would prefer split doors on the unit, please state on your order (not available in 400mm wide)

integrated appliance fascias

built under fridge / dw / washer door	integrated dishwasher door	semi integrated dishwasher door	boiler door	wall plant on panel	end support panel	tall plant on panel	large universal panel / breakfast bar back panel	small breakfast bar back panel
768 x 595mm	768 x 446mm	625 x 596mm	950 x 600mm	960 x 360mm	900 x 650mm	2430 x 650mm	910 x 2450mm	900 x 1200mm
AD60FD	AD45I	AD60S	BLD9L/R	PWEP9	ESP	PTEP2	LUP	BBP
£436	£381	£392	£513	£188	£188	£383	£487	£244

T&G panels

wall plant on panel	end support panel	tall plant on panel	large universal panel/breakfast bar back panel	small breakfast bar back panel	chopping boards & trays unit	canopy	mantle shelf	shelf bracket (1 no.)	plate rack (oak only)
960 x 360mm	900 x 650mm	2430 x 650mm	910 x 2450mm	900 x 1200mm	770 x 200mm	note: a 900x1200 panel is supplied to clad the underside of the canopy 1200 x 575 x 165mm (can be trimmed to 1000mm)	1752 x 130 x 170mm	166 x 125 x 21mm	1200mm to be cut to size
PWEP9-TG	ESP-TG	PTEP2-TG	LUP-TG	BBP-TG	CBTR	CPY	MTSK	SHB	PRK
£241	£241	£552	£595	£300	£1,530	£2,604	£696	£120	£240

accessories / trims

wine rack rail (oak only)	modular pilaster		modular pilaster bead	plinth	curved plinth	skirting plinth	curved skirting plinth	feature plinth	traditional cornice	under cornice
1200 x 63mm to be cut to size	use the bead as a filler in the back of the pilaster when being used as a leg									
WRK	MP900	MP2400	MPBD	PL	CVPL	SKPL	CVSKPL	FTPL	SCCRN	UCRN
£73	£196	£373	£70	£168	£205	£188	£481	£168	£282	£241

accessories / trims

curved cornice	curved under cornice	curved end post	curved end post cap	curved end post under cornice	curved end post base cap (for skirting plinth)	tall feature end post	frame profile 37mm	frame profile 68mm
350 x 350 x 90mm	350 x 350 x 50mm	2450 x 50 x 70mm	38 x 38 x 90mm	48 x 48 x 50mm	64 x 64 x 135mm	3050 x 60 x 35mm	1500 x 37 x 20mm	1500 x 68 x 20mm
CVCRN	CVUCRN	CVP	CPBSC	CVEUCRN	CVEBC	FEP	FPR37	FPR68
£461	£319	£167	£191	£537	£163	£136	£123	£173

accessories / trims

edging tape roll (veneered)	touch up paint	care kit	touch up paint 1L tin
oak (10m) unfinished	20ml		1 Litre
ET	TUP	CK	TUP-1L
£35	£46	£81	£136

Durham available on oak cabinet only.
Handle options - see pages 80-86.
See page 10-11 for lead times.
See page 66 for made to measure timber panels

† Touch up paints and care kits should only be used for minor repairs to backs and edges of doors. They should not be used on door fronts

↑ grain direction

Handles

Our suite of handles has been carefully chosen to complement our kitchens.



H1070 Short Rear Fix Handle
Matt Black
180mm Long x 18mm High
160mm Centres | 40mm Depth
£11



H1071 Long Rear Fix Handle
Matt Black
275mm Long x 18mm High
256mm Centres | 40mm Depth
£13



H1072 Short Rear Fix Handle
Brushed Gold
180mm Long x 18mm High
160mm Centres | 40mm Depth
£11



H1073 Long Rear Fix Handle
Brushed Gold
275mm Long x 18mm High
256mm Centres | 40mm Depth
£13



H1011 Curved End D Handle
Brushed Nickel
200mm Long x 16mm Thick
192mm Centres | 25mm Projection
£16



H1013 Curved End D Handle
Chrome
200mm Long x 16mm Thick
192mm Centres | 25mm Projection
£16



H1015 Curved End D Handle
Copper
200mm Long x 16mm Thick
192mm Centres | 25mm Projection
£16



H1032 Curved End D Handle
Satin Brass
200mm Long x 16mm Thick
192mm Centres | 25mm Projection
£23



H1007 Long Rear Fix Handle
Chrome
200mm Long x 10mm High
160mm Centres | 15mm Depth
£18



H1003 Long Front Fix Handle
Chrome
275mm Long x 18mm High
256mm Centres | 40mm Depth
£15



H941 Square D Handle
Chrome
200mm Long x 10mm Thick
160/192mm Centres | 30mm Projection
£16



H947 Square D Handle
Chrome
205mm Long x 25mm Thick
160/192mm Centres | 30mm Projection
£17



H1076 Knurled Knob
Matt Black
25mm Diameter
26mm Projection
£10



H1077 Knurled D Handle
Matt Black
152mm Long x 12mm Thick
128mm Centres | 34mm Projection
£14



H1078 Knurled Knob
Brushed Nickel
25mm Diameter
26mm Projection
£10



H1079 Knurled D Handle
Brushed Nickel
152mm Long x 12mm Thick
128mm Centres | 34mm Projection
£14



H933 Tapered Base D Handle
Satin Nickel
170mm Long x 22mm Thick
160mm Centres | 30mm Projection
£13



H003 Bevelled Strap Handle
Satin Nickel
152mm Long x 24mm Thick
128mm Centres | 25mm Projection
£11



H931 Curved Strap Handle
Satin Nickel
177mm Long x 27mm Thick
160mm Centres | 37mm Projection
£16



H932 Slim Curved Strap Handle
Satin Nickel
206mm Long x 15mm Thick
192mm Centres | 24mm Projection
£10



H1065 Knurled Bar Handle
Stainless Steel
220mm Long x 12mm Thick
160mm Centres | 32mm Projection
£14



H1066 Knurled Bar Handle
Rose Gold
220mm Long x 12mm Thick
160mm Centres | 32mm Projection
£15



H1067 Knurled Bar Handle
Matt Black
220mm Long x 12mm Thick
160mm Centres | 32mm Projection
£15



H820 Round Collared Bar Handle
Stainless Steel
165mm Long x 16mm Thick
128mm Centres | 30mm Projection
£14



H918 Rounded D Handle
Satin Nickel
150mm Long x 20mm Thick
128mm Centres | 28mm Projection
£10



H146 Tapered D Handle
Satin Nickel
180mm Long x 20mm Thick
160mm Centres | 35mm Projection
£13



H1018 Tapered Strap Handle
Stainless Steel
200mm Long x 17mm Thick
160mm Centres | 29mm Projection
£32



H1019 Tapered Strap Handle
Black Chrome
200mm Long x 17mm Thick
160mm Centres | 29mm Projection
£30



H917 Round Bar Handle
Stainless Steel
185mm Long x 16mm Thick
160mm Centres | 38mm Projection
£13



H264 Round Bar Handle
Stainless Steel
200mm Long x 14mm Thick
160mm Centres | 34mm Projection
£14



H222 Slim Round Bar Handle
Stainless Steel
220mm Long x 12mm Thick
160mm Centres | 30mm Projection
£14



H318 Round Bar Handle
Stainless Steel
236mm Long x 16mm Thick
177mm Centres | 36mm Projection
£15

Handles

Our suite of handles has been carefully chosen to complement our kitchens.



H1038 Flared D Handle
Chocolate
169mm Long x 26mm Thick
160mm Centres | 27mm Projection
£23



H1039 Flared D Handle
Graphite
169mm Long x 26mm Thick
160mm Centres | 27mm Projection
£23



H1040 Flared D Handle
Copper
169mm Long x 26mm Thick
160mm Centres | 27mm Projection
£23



H1033 Slim Square D Handle
Satin Brass
186mm Long x 9mm Thick
160mm Centres | 27mm Projection
£16



H1108 Curved D Handle
Brushed Satin Nickel
147mm Long x 15mm Thick
128mm Centres | 28mm Projection
£18



H1107 Square Knob
Brushed Satin Nickel
34mm Diameter
25mm Projection
£12



H1106 Curved D Handle
American Bronze
147mm Long x 15mm Thick
128mm Centres | 28mm Projection
£18



H1105 Square Knob
American Bronze
34mm Diameter
25mm Projection
£12



H1074 Square D Handle
Matt Black OceanIX Recycled Plastic
138mm Long x 10mm Thick
128mm Centres | 32mm Projection
£15



H1075 Round Knob
Matt Black OceanIX Recycled Plastic
43mm Diameter
24mm Projection
£15



H962 Angular Strap Handle
Brushed Copper
200mm Long x 18mm Thick
160mm Centres | 30mm Projection
£24



H363 Cross Detail D Handle
Pewter Effect
140mm Long x 18mm Thick
128mm Centres | 28mm Projection
£13



H1104 D Handle with back plate
Brushed Satin Brass
170mm Long x 21mm Thick
128mm Centres | 38mm Projection
£32



H1103 Knob with back plate
Brushed Satin Brass
32mm Diameter | 32mm Projection
Backplate: 56mm long
£18



H1102 D Handle with back plate
American Bronze
170mm Long x 21mm Thick
128mm Centres | 38mm Projection
£32



H1101 Knob with back plate
American Bronze
32mm Diameter | 32mm Projection
Backplate: 56mm long
£18



H504 Arched Strap Handle
Antique Effect
175mm Long x 19mm Thick
96mm Centres | 26mm Projection
£13



H942 Arched Strap Handle
Antique Effect
140mm Long x 26mm Thick
96mm Centres | 24mm Projection
£10



H943 Cup Handle
Antique Effect
96mm Long x 30mm High
64mm Centres | 20mm Projection
£10



H1009 Round Knob
Antique Effect
40mm Diameter
35mm Projection
£10



H1098 Bar Handle
Matt Black
210mm Long x 19mm Thick
128mm Centres | 37mm Projection
£30



H1097 T-Bar Knob
Matt Black
82mm Long x 19mm Thick
37mm Projection
£17



H1096 Bar Handle
Polished Nickel
210mm Long x 19mm Thick
128mm Centres | 37mm Projection
£30



H1095 T-Bar Knob
Polished Nickel
82mm Long x 19mm Thick
37mm Projection
£17



H150 Cup Handle
Chrome
90mm Long x 42mm High
76mm Centres | 20mm Projection
£13



H149 Round Knob
Chrome
25mm Diameter
30mm Projection
£13



H1080 Cup Handle
Matt Black
90mm Long x 42mm High
76mm Centres | 20mm Projection
£13



H1081 Round Knob
Matt Black
36mm Diameter
45mm Projection
£13



H1100 Bar Handle
Dark Brushed Brass
210mm Long x 19mm Thick
128mm Centres | 37mm Projection
£30



H1099 T-Bar Knob
Dark Brushed Brass
82mm Long x 19mm Thick
37mm Projection
£17



H1044 Cup Handle
Satin Brass
97mm Long x 37mm High
64mm Centres / 24mm Projection
£17



H1043 Round Knob
Satin Brass
40mm Diameter x 35mm High
£15

100%
RECYCLED

Handles

Our suite of handles has been carefully chosen to complement our kitchens.



H1051 Cup Handle
American Copper
104mm Long x 48mm High
64mm Centres | 30mm Projection
£24



H1052 Knob
American Copper
38mm Diameter
32mm Projection
£18



H1049 Cup Handle
Black Nickel
104mm Long x 48mm High
64mm Centres | 30mm Projection
£23



H1050 Knob
Black Nickel
38mm Diameter
32mm Projection
£17



H1082 Bar Handle (no back plate)
Dark Brushed Brass
180mm Long x 20mm Thick
160mm Centres | 30mm Projection
£35



H1083 Cup Handle
Dark Brushed Brass
105mm Wide x 45mm High
64mm Centres | 24mm Projection
£30



H1084 Knob (no back plate)
Dark Brushed Brass
32mm Diameter | 29mm Projection
£19



H1086 Smooth Eclipse Handle
Dark Brushed Brass
80mm Wide x 40mm High
64mm Centres | 26mm Projection
£26



H1045 Cup Handle
Brushed Copper
104mm Long x 48mm High
64mm Centres | 30mm Projection
£23



H1046 Knob
Brushed Copper
38mm Diameter
32mm Projection
£17



H1047 Cup Handle
Brushed Satin Brass
104mm Long x 48mm High
64mm Centres | 30mm Projection
£26



H1048 Knob
Brushed Satin Brass
38mm Diameter
32mm Projection
£18



H1082B Bar Handle (with back plate)
Dark Brushed Brass
190mm Long x 25mm Thick
160mm Centres | 34mm Projection
£49



H1083 Cup Handle
Dark Brushed Brass
105mm Wide x 45mm High
64mm Centres | 24mm Projection
£30



H1084B Knob (with back plate)
Dark Brushed Brass
32mm Diameter | 33mm Projection
Back Plate: 100mm Long x 25mm Wide
£28

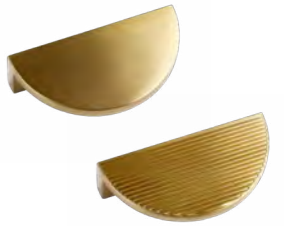

H1085 Ribbed Eclipse Handle
Dark Brushed Brass
80mm Wide x 40mm High
64mm Centres | 26mm Projection
£26



H1057 Scalloped Cup Handle
Brushed Satin Nickel
155mm Long x 31mm High
128mm Centres | 29mm Projection
£35



H1058 Round Scalloped Knob
Brushed Satin Nickel
40mm Diameter
37mm Projection
£27



H1055 Scalloped Cup Handle
Black Nickel
155mm Long x 31mm High
128mm Centres | 29mm Projection
£36



H1056 Scalloped Knob
Black Nickel Round
40mm Diameter
37mm Projection
£28

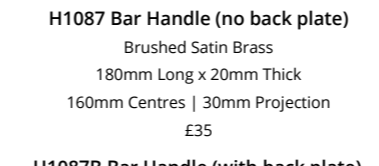

H1087 Bar Handle (no back plate)
Brushed Satin Brass
180mm Long x 20mm Thick
160mm Centres | 30mm Projection
£35



H1088 Cup Handle
Brushed Satin Brass
105mm Wide x 45mm High
64mm Centres | 24mm Projection
£30



H1089 Knob (no back plate)
Brushed Satin Brass
32mm Diameter | 29mm Projection
£19

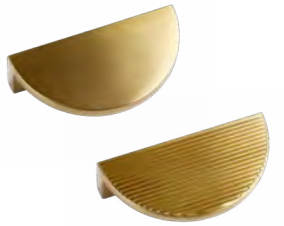

H1091 Smooth Eclipse Handle
Brushed Satin Brass
80mm Wide x 40mm High
64mm Centres | 26mm Projection
£26



H1053 Scalloped Cup Handle
American Copper
155mm Long x 31mm High
128mm Centres | 29mm Projection
£37



H1054 Scalloped Knob
American Copper Round
40mm Diameter
37mm Projection
£27



H1030 Cup Handle
Antique Bronze
95mm Long x 30mm High
64mm Centres | 28mm Projection
£17



H1031 Knob
Antique Bronze
30mm Diameter x 26mm High
£17



H1092 Bar Handle (no back plate)
Matt Black
180mm Long x 20mm Thick
160mm Centres | 30mm Projection
£35



H1093 Cup Handle
Matt Black
105mm Wide x 45mm High
64mm Centres | 24mm Projection
£30



H1094 Knob (no back plate)
Matt Black
32mm Diameter | 29mm Projection
£19



H1094B Knob (with back plate)
Matt Black
32mm Diameter | 33mm Projection
Back Plate: 100mm Long x 25mm Wide
£28



H1092B Bar Handle (with back plate)
Matt Black
190mm Long x 25mm Thick
160mm Centres | 34mm Projection
£49

Handles

Our suite of handles has been carefully chosen to complement our kitchens.

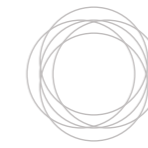

FORM BY LOCHANNA



H1059 Bevelled D Handle
Brushed Satin Nickel
142mm Long x 14mm High
128mm Centres | 34mm Projection
£19

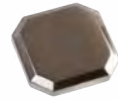

H1060 Bevelled Knob
Brushed Satin Nickel
34mm Long x 34mm High
23mm Projection
£16



H1061 Bevelled D Handle
Chrome
142mm Long x 14mm High
128mm Centres | 34mm Projection
£19

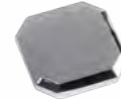

H1062 Bevelled Knob
Chrome
34mm Long x 34mm High
23mm Projection
£16



H1020 Cup Handle
Chrome
130mm Long x 38mm High
64mm Centres | 28mm Projection
£23



H1022 Cup Handle
Chrome
104mm Long x 32mm High
64mm Centres | 23mm Projection
£13



H1025 Round Knob
Chrome
59mm Long x 43mm High
38mm Projection
£17



H1027 Square Knob
Chrome
59mm Long x 43mm High
38mm Projection
£17



H1024 Cup Handle
Black Satin
104mm Long x 32mm High
64mm Centres | 23mm Projection
£13



H1026 Round Knob
Black Satin
59mm Long x 43mm High
38mm Projection
£17



H1028 Square Knob
Black Satin
59mm Long x 43mm High
38mm Projection
£18



contents

FORM - our door selector	74 - 75
FORM - range overview	76 - 77

FORM price groups

one - mala	78 - 80
two - eterna	81 - 83
three - strato	84 - 86
four - elswick	87 - 89

FORM - rails and fittings	90 - 97
FORM - technical information	116 - 119

FORM Door Selector

The door choice in LochAnna FORM has been carefully selected from the very best Italian and British manufacturers. We have chosen only the finest painted smooth gloss and matt finishes, complemented by a broad colour choice of solid timbers and veneered woodgrains. Consider your handleless rail colour and open shelving – mixing colour, texture and style will create a truly individual kitchen. Your designer will be happy to guide you through the process.



Mala
Manufactured and painted in Italy – in a mix of gloss and matt finishes.



Eterna
Made from 100% recycled material, the bold Eterna finishes make a statement.

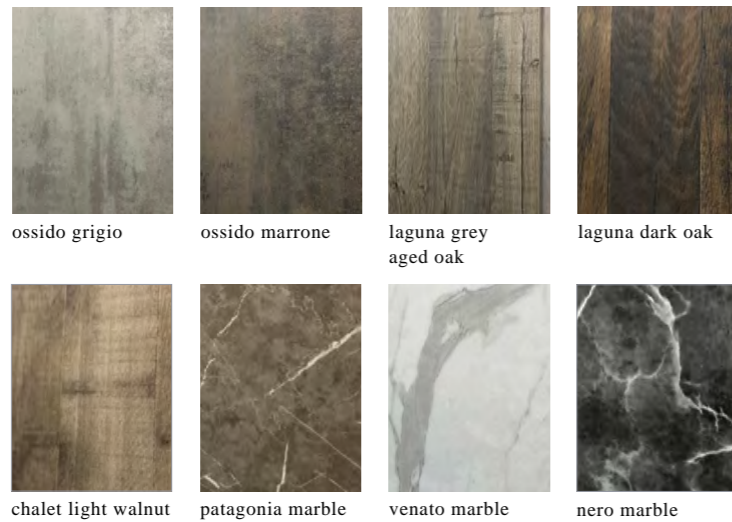

Elswick
A rich solid timber narrow framed shaker door, with a veneered centre panel.

Available in 33 stunning painted finishes or our Colour Match Service.

Note: As timber doors are made from a natural living material, some grain variation can be expected within products. This is normal and is considered to add an authentic look and feel to the products.

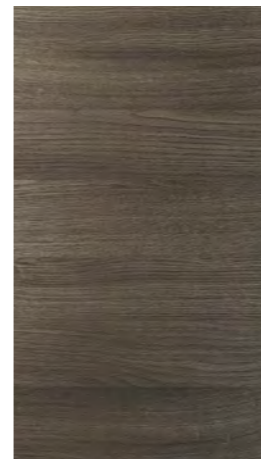

Strato
A classic Italian veneered flat door - will work well alongside Mala.

Available in 33 painted finishes, our Colour Match Service or six natural stains*

Note: Strato is manufactured with an oak veneer. Veneers are randomly selected and as a consequence, each door will be different in grain structure and can have variation in colour when stained. There is a horizontal grain on the doors.



Colour MATCHING Service

Note: Colours are as accurate as the printing process allows, we recommend that you examine a physical swatch or sample before making your final choice. These can be requested via your retailer.

Range Overview

	Colour	Door thickness	Door material	End panels	930 corner base configuration	Conventional corner base	Conventional corner wall post	360 walls	575 walls	720 walls	Lead time											
mala	gloss white	18mm	Slab HDF painted, polyurethane lacquered	Slab HDF painted, polyurethane lacquered	297mm doors, 70 x 70mm post	Mullion kit included. Same post as 930 base	Mullion kit included. 150 door for post	YES	YES	YES	4 weeks											
	gloss porcelain																					
	gloss cashmere																					
	gloss dove grey																					
	gloss dust grey																					
	gloss graphite																					
	matt white	18mm	Slab HDF painted	Slab HDF painted	297mm doors, 70 x 70mm post (assembled on site)	Mullion kit included. Same post as 930 base	Mullion kit included. 150 door for post	YES	YES	YES	4 weeks											
	matt porcelain																					
	matt cashmere																					
	matt dove grey																					
	matt platinum grey																					
	matt graphite																					
	matt dust grey																					
	matt navy blue																					
	matt moss green																					
	matt taupe grey																					
	eterna											ossido grigio	18mm	Saviola 100% recycled MFC board, PVC edge	Saviola 100% recycled MFC board, PVC edge	297mm doors, 70 x 70mm post	Mullion kit included. Same post as 930 base	Mullion kit included. 150 door for post	YES	YES	YES	4 weeks
												ossido marrone										
venato marble																						
patagonia marble																						
nero marble																						
chalet light walnut																						
laguna grey aged oak																						
laguna dark oak																						
elswick	aegean	21mm	Painted/ Lacquered ash	19mm Painted/ Lacquered veneered MDF	297mm doors, 70 x 70 mm post	Mullion kit included. Same post as 930 base	Mullion kit included. 150 door for post	YES	YES	YES	6 weeks											
	atlantic																					
	auburn																					
	breeze																					
	brigade																					
	bright white																					
	cashmere																					
	damson																					
	desert pink																					
	dust grey																					
	graphite																					
	heather green																					
	indigo																					
	ivory																					
	laurel green																					
	light grey																					
	meadow																					
	midnight grey																					
	mussel																					
	olive																					
	pale teal																					
	pearl																					
	pebble grey																					
	porcelain																					
	sage																					
	sapphire																					
	soft black																					
	soot																					
steel grey																						
stone																						
taupe																						
thicket																						
warm earth																						

Range Overview

	Colour	Door thickness	Door material	End panels	930 corner base configuration	Conventional corner base	Conventional corner wall post	360 walls	575 walls	720 walls	Lead time
strato	aegean	19mm	Painted/ lacquered oak veneered, visible grain, 1.6mm edging	19mm Painted/ Lacquered veneered furniture board	297mm doors, 70 x 70mm post	Mullion kit included. Same post as 930 base	Mullion kit included. 150 door for post	YES	YES	YES	5 weeks
	atlantic										
	auburn										
	breeze										
	brigade										
	bright white										
	cashmere										
	damson										
	desert pink										
	dust grey										
	graphite										
	heather green										
	indigo										
	ivory										
	laurel green										
	light grey										
	meadow										
	midnight grey										
	mussel										
	olive										
	pale teal										
	pearl										
	pebble grey										
	porcelain										
	sage										
	sapphire										
	soft black										
	soot										
steel grey											
stone											
taupe											
thicket											
warm earth											
buff											
pale oak											
bronze											
mezzo											
mocha											
charcoal black											



Colour
MATCHING
Service

For Elswick & Strato Colour Matching Service, add up to 3 weeks to the lead times shown. See page 9 for how to order.

highline base units														
base unit with VS SUB pull out	150mm trays	300mm	single base units						double base units					
code	BP15TY	BP3TY	code	BH15	BH30	BH40	BH45	BH50	BH60	code	BH70	BH80	BH90	BH100
	£383	£619		£211	£242	£266	£278	£286	£317		£386	£427	£444	£462
			base units with pull out bin	300mm	400mm	450mm	500mm	600mm	600mm					
			code	BH3B	BH4B	BH45B	BH5B	BH6B4	BH6B2					
				£593	£679	£696	£710	£821	£772					

wall units (575mm high cabinets)															
single wall units	300 mm	400 mm	450 mm	500 mm	600 mm	double wall units				800 mm	900 mm	1000 mm	corner wall units	600 mm	900 mm
code	W357	W457	W4557	W557	W657	code				W857	W957	W157	code	WC657	WC957
	£193	£206	£225	£255	£257					£349	£370	£389		£344	£424

highline corner units															
corner base units 800mm	300mm door	400mm door	450mm door	corner base units 900mm	450mm door	corner base units 1000mm	450mm door	500mm door	600mm door	corner base units 1000mm with VS CORNERSTONE MAXX pull out			500mm door	600mm door	
code	BC83	BC84	BC845	code	BC945	code	BC145	BC15	BC16	LH wirework			BCL15L	BCL16L	
	£446	£463	£470	£473	£481	£486	£503		£1309	£1386	RH wirework			BCL15R	BCL16R
											Note: the back of the loose shelf requires trimming				
											£559	£641	£660	£692	

feature wall units													
720 high bi-fold units with Blum Aventos	600 mm	800 mm	900 mm	1000 mm	bridging units 360mm high (with Blum Aventos HK-S)				600 mm	800 mm	900 mm	1000 mm	
code	WBI60	WBI80	WBI90	WBI10	code				WB63	WB83	WB93	WB13	
	£559	£641	£660	£692					£284	£338	£352	£368	

highline corner units													
corner base units 900mm with VS COR FLEX pull out	450mm door	corner base units 1000mm with VS COR FLEX pull out	450mm door	500mm door	600mm door	930L corner base units	930mm	island base units (270mm reduced depth)	500mm	1000mm			
code	BCO945	code	BCO145	BCO15	BCO16	code	BCL9	code	BI50	BI10			
	£1434		£1442	£1447	£1460		£689		£265	£430			
										see separate tech guide for more info			

feature wall units						appliance doors				
smoked glass wall unit 720mm high	500 mm	600 mm	reeded glass wall unit 720mm high	500 mm	600 mm	integrated extractor door	built under fridge / dw / washer door	integrated dishwasher door	semi integrated dishwasher door	boiler door
code	WG5	WG6	code	WGR5	WGR6	450 x 600mm	685 x 600mm	685 x 450mm	570 x 600mm	895 x 600mm
	£441	£485		£441	£485					
8mm glass shelf	£66	£66	8mm glass shelf	£66	£66	£82	£109	£91	£96	£156

drawer packs																														
3 drawer unit (1 pan)					2 drawer unit (2 pan)					2 drawer unit with internal drawer (1 pan)																				
500mm					600mm					800mm						900mm						1000mm								
BD53	BD63	BD83	BD93	BD13	BD52	BD62	BD82	BD92	BD12	BD52I	BD62I	BD82I	BD92I	BD12I	BD52I	BD62I	BD82I	BD92I	BD12I	BD52I	BD62I	BD82I	BD92I	BD12I						
excel	£525	£571	£668	£694	£730	£454	£495	£577	£608	£633	£586	£635	£739	£776	£806	£865	£911	£1008	£1034	£1070	£734	£775	£857	£888	£913	£926	£975	£1079	£1116	£1146

panels									
end support	wall plant on	tall plant on	breakfast bar back panel	large universal panel / breakfast bar back panel	breakfast bar / island end panels				
900 x 650mm	797 x 355 x 18mm	2400 x 650mm	900 x 1200mm	900 x 2400 x 18mm	685 x 1200 x 18mm	685 x 397 x 18mm	685 x 497 x 18mm	685 x 597 x 18mm	
ESP	PWEP8	PTEP	BBP	LUP	IP612	IP64	IP65	IP66	
£172	£172	£457	£298	£594	£219	£84	£96	£113	

wall units (720mm high cabinets)																	
single wall units	260 mm	300 mm	400 mm	450 mm	500 mm	600 mm	double wall units				700 mm	800 mm	900 mm	1000 mm	standard corner wall units	600 mm	900 mm
code	W26	W30	W40	W45	W50	W60	code				W70	W80	W90	W100	code	WC60	WC90
	£200	£221	£238	£258	£274	£301					£370	£406	£425	£453		£378	£470

trims & accessories							
plinth	universal cornice / pelmet	internal base corner post (matt is a 2 piece post)	external base corner post	tall feature end post (matt only)	gloss touch up paint	matt touch up paint kit	wall unit base shelf for canopy extractor
3050 x 150 x 16mm	3000 x 50 x 28mm	685 x 70 x 18mm	685 x 46 x 46mm	3000 x 100 x 50mm	20ml	11ml	1000 x 310mm
PL	SQPEL	BCP68	EXCP68	FEP	TUP	TUPK	EBSK
£120	£135	£66	£92	£375	£43	£66	£148

price group

one - mala

Price of drawers includes LochAnna Excel soft close drawer boxes. Units supplied with titanium soft closing hinges.

See pages 90 - 97 for handleless profile rail prices.

appliance housings						
	double oven housing unit 2 door (495 & 570 door)	single oven housing unit 2 door (645 & 715 door)	single oven micro housing unit 2 door (450 & 450 door)	50/50 fridge freezer unit	70/30 fridge freezer unit	600mm built under oven housing
	600mm	600mm	600mm	600mm	600mm	Fixed panel
LH Hinge	AH-DOL	AH-SOL	AH-SMWL	AH-F55	AH-F73	BOH6
RH Hinge	AH-DOR	AH-SOR	AH-SMWR			
	£645	£689	£656	£648	£635	£184

larders						
	larder unit 2 door			larder unit 1 door		larder unit with VS TAL Larder pull out
	300mm	500mm	600mm	500mm	600mm	300mm
Code	L3	L5	L6	L5SD	L6SD	LP3
	£618	£669	£713	£669	£713	£1370

larders					
	larder drawer tower with excel plus glass drawers 2 door			larder drawer tower with excel plus glass drawers 1 door	
	300mm	500mm	600mm	500mm	600mm
Code	LT3	LT5	LT6	LT5SD	LT6SD
	£1433	£1601	£1693	£1601	£1693

larders								
	larder unit with VS TAL Gate Pro pull out 2 doors		larder unit with VS TAL Gate Pro pull out 1 door		larder unit with VS TAL Gate pull out 2 doors		larder unit with VS TAL Gate pull out 1 door	
	500mm	600mm	500mm	600mm	500mm	600mm	500mm	600mm
Code	LP5T	LP6T	TLP5T	LP6TSD	LP5TS	LP6TS	LP5TSSD	LP6TSSD
	£1804	£1842	£1804	£1842	£1558	£1653	£1558	£1653

highline base units														
base unit with VS SUB pull out	150mm trays	300mm	single base units	150mm	300mm	400mm	450mm	500mm	600mm	double base units	700mm	800mm	900mm	1000mm
code	BP15TY	BP3TY	code	BH15	BH30	BH40	BH45	BH50	BH60	code	BH70	BH80	BH90	BH100
	£383	£619		£211	£242	£266	£278	£286	£317		£386	£427	£444	£462
			base units with pull out bin	300mm	400mm	450mm	500mm	600mm	600mm					
			code	BH3B	BH4B	BH45B	BH5B	BH6B4	BH6B2					
				£593	£679	£696	£710	£821	£772					

highline corner units													
corner base units 800mm	300mm door	400mm door	450mm door	corner base units 900mm	450mm door	corner base units 1000mm	450mm door	500mm door	600mm door	corner base units 1000mm with VS CORNERSTONE MAXX pull out	500mm door	600mm door	
code	BC83	BC84	BC845	code	BC945	code	BC145	BC15	BC16	LH wirework	BCL15L	BCL16L	
		£446	£463	£470		£473		£481	£486	£503	RH wirework	BCL15R	BCL16R
											£1309	£1386	
										(RH Shown)		soft close as standard	

highline corner units											
corner base units 900mm with VS COR FLEX pull out	450mm door	corner base units 1000mm with VS COR FLEX pull out	450mm door	500mm door	600mm door	930L corner base units	930mm	island base units (270mm reduced depth)	500mm	1000mm	
code	BCO945	code	BCO145	BCO15	BCO16	code	BCL9	code	BI50	BI10	
		£1434		£1442	£1447	£1460		£689		£265	£430
									see separate tech guide for more info		

drawer packs															
	3 drawer unit (1 pan)					2 drawer unit (2 pan)					2 drawer unit with internal drawer (1 pan)				
	500mm	600mm	800mm	900mm	1000mm	500mm	600mm	800mm	900mm	1000mm	500mm	600mm	800mm	900mm	1000mm
	BD53	BD63	BD83	BD93	BD13	BD52	BD62	BD82	BD92	BD12	BD52I	BD62I	BD82I	BD92I	BD12I
excel	£525	£571	£668	£694	£730	£454	£495	£577	£608	£633	£586	£635	£739	£776	£806
legrabox	£865	£911	£1008	£1034	£1070	£734	£775	£857	£888	£913	£926	£975	£1079	£1116	£1146

wall units (720mm high cabinets)															
single wall units	260 mm	300 mm	400 mm	450 mm	500 mm	600 mm	double wall units	700 mm	800 mm	900 mm	1000 mm	standard corner wall units	600 mm	900 mm	
code	W26	W30	W40	W45	W50	W60	code	W70	W80	W90	W100	code	WC60	WC90	
		£200	£221	£238	£258	£274	£301		£370	£406	£425	£453		£378	£470

price group

one - mala



price group





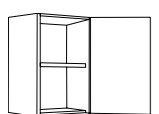
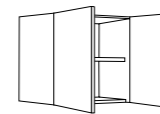
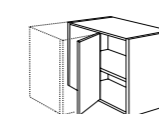

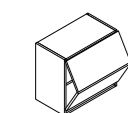
two - eterna



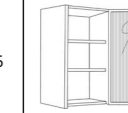

Price of drawers includes LochAnna Excel soft close drawer boxes. Units supplied with titanium soft closing hinges.

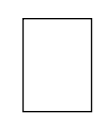
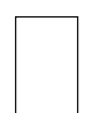

See pages 90 - 97 for handleless profile rail prices.

wall units (575mm high cabinets)												
single wall units	300 mm	400 mm	450 mm	500 mm	600 mm	double wall units	800 mm	900 mm	1000 mm	corner wall units	600 mm	900 mm
code	W357	W457	W4557	W557	W657	code	W857	W957	W157	code	WC657	WC957
	£193	£206	£225	£255	£257		£349	£370	£389		£344	£424

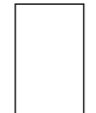
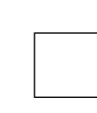
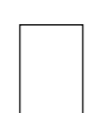
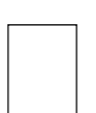

feature wall units										
720 high bi-fold units with Blum Aventos	600 mm	800 mm	900 mm	1000 mm	bridging units 360mm high (with Blum Aventos HK-S)	600 mm	800 mm	900 mm	1000 mm	
code	WBI60	WBI80	WBI90	WBI10	code	WB63	WB83	WB93	WB13	
	Note: the back of the loose shelf requires trimming					£284	£338	£352	£368	
	£559	£641	£660	£692						

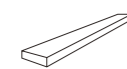
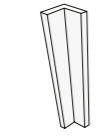
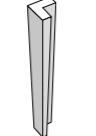
feature wall units					appliance doors					
smoked glass wall unit 720mm high	500 mm	600 mm	reeded glass wall unit 720mm high	500 mm	600 mm	integrated extractor door	built under fridge / dw / washer door	integrated dishwasher door	semi integrated dishwasher door	boiler door
code	WG5	WG6	code	WGR5	WGR6	450 x 600mm	685 x 600mm	685 x 450mm	570 x 600mm	895 x 600mm
	£441	£485		£441	£485					
8mm glass shelf	£66	£66	8mm glass shelf	£66	£66	£82	£109	£91	£96	£142

panels							
end support	wall plant on	tall plant on	large universal panel / breakfast bar back panel	breakfast bar / island end panels			
900 x 650mm	960 x 360mm	2430 x 650mm	2400 x 900mm	685 x 1200 x 19mm	685 x 397 x 19mm	685 x 497 x 19mm	685 x 597 x 19mm
ESP	PWEP96	PTEP	LUP	IP612	IP64	IP65	IP66
							
£172	£172	£457	£594	£219	£84	£96	£113

trims & accessories					
plinth	modern cornice / pelmet	internal base corner post	external base corner post	edging tape roll	wall unit base shelf for canopy extractor
2800 x 150mm	2800 x 18 x 70mm	685 x 70 x 18mm	685 x 46 x 46mm	10m	1000 x 310mm
PL	SQPEL	BCP68	EXCP68	ET	EBSK
					
£120	£62	£66	£92	£35	£148

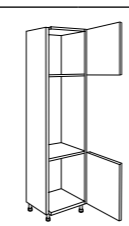
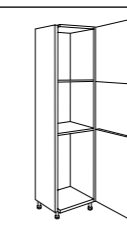
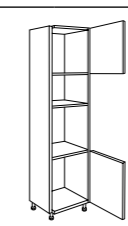
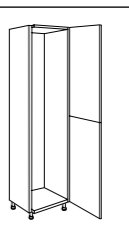
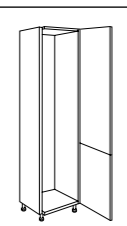
Ⓢ = Vertical grain direction

appliance housings						
	double oven housing unit 2 door (495 & 570 door)	single oven housing unit 2 door (645 & 715 door)	single oven micro housing unit 2 door (450 & 450 door)	50/50 fridge freezer unit	70/30 fridge freezer unit	600mm built under oven housing
	600mm	600mm	600mm	600mm	600mm	Fixed panel
LH Hinge	AH-DOL	AH-SOL	AH-SMWL	AH-F55	AH-F73	BOH6
RH Hinge	AH-DOR	AH-SOR	AH-SMWR			
						
	£645	£689	£656	£648	£635	£184

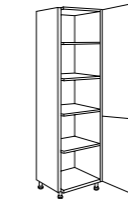
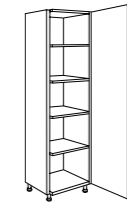
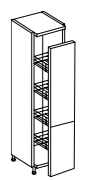
larders						
	larder unit 2 door			larder unit 1 door		larder unit with VS TAL Larder pull out
	300mm	500mm	600mm	500mm	600mm	300mm
Code	L3	L5	L6	L5SD	L6SD	LP3
						
	£618	£669	£713	£669	£713	£1370

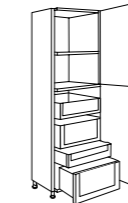
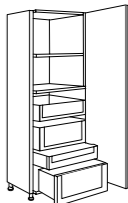
larders					
	larder drawer tower with excel plus glass drawers 2 door			larder drawer tower with excel plus glass drawers 1 door	
	300mm	500mm	600mm	500mm	600mm
Code	LT3	LT5	LT6	LT5SD	LT6SD
					
	£1434	£1601	£1693	£1601	£1693

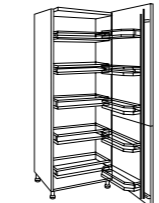
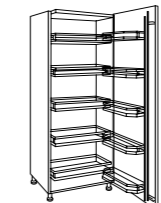
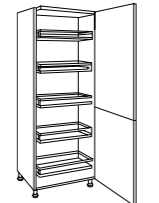
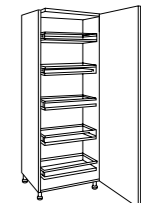
larders								
	larder unit with VS TAL Gate Pro pull out 2 doors		larder unit with VS TAL Gate Pro pull out 1 door		larder unit with VS TAL Gate pull out 2 doors		larder unit with VS TAL Gate pull out 1 door	
	500mm	600mm	500mm	600mm	500mm	600mm	500mm	600mm
Code	LP5T	LP6T	TLP5T	LP6TSD	LP5TS	LP6TS	LP5TSSD	LP6TSSD
								
	£1804	£1842	£1804	£1842	£1558	£1653	£1558	£1653

price group

two - eterna

highline base units														
base unit with VS SUB pull out	150mm trays	300mm	single base units						double base units					
code	BP15TY	BP3TY	code	BH15	BH30	BH40	BH45	BH50	BH60	code	BH70	BH80	BH90	BH100
	£418	£660		£246	£283	£312	£342	£352	£391		£460	£519	£572	£594
			base units with pull out bin	300mm	400mm	450mm	500mm	600mm	600mm					
			code	BH3B	BH4B	BH45B	BH5B	BH6B4	BH6B2					
				£634	£725	£760	£776	£899	£850					

highline corner units												
corner base units 800mm	300mm door	400mm door	450mm door	corner base units 900mm	450mm door	corner base units 1000mm	450mm door	500mm door	600mm door	corner base units 1000mm with VS CORNERSTONE MAXX pull out	500mm door	600mm door
code	BC83	BC84	BC845	code	BC945	code	BC145	BC15	BC16	LH wirework	BCL15L	BCL16L
	£602	£624	£649		£652		£660	£667	£692	RH wirework	BCL15R	BCL16R
											£1490	£1575
										(RH Shown)	soft close as standard	

highline corner units															
corner base units 900mm with VS COR FLEX pull out	450mm door	corner base units 1000mm with VS COR FLEX pull out	450mm door	500mm door	600mm door	930L corner base units	930mm	island base units (270mm reduced depth)	500mm	1000mm					
code	BCO945	code	BCO145	BCO15	BCO16	code	BCL9	code	BI50	BI10					
	£1613		£1621	£1628	£1653		£886		£331	£562					
											see separate tech guide for more info				

drawer packs															
3 drawer unit (1 pan)					2 drawer unit (2 pan)					2 drawer unit with internal drawer (1 pan)					
500mm	600mm	800mm	900mm	1000mm	500mm	600mm	800mm	900mm	1000mm	500mm	600mm	800mm	900mm	1000mm	
BD53	BD63	BD83	BD93	BD13	BD52	BD62	BD82	BD92	BD12	BD52I	BD62I	BD82I	BD92I	BD12I	
excel	£632	£701	£827	£877	£929	£540	£599	£703	£742	£787	£672	£739	£865	£910	£960
legrabox	£972	£1041	£1167	£1217	£1269	£820	£879	£983	£1022	£1067	£1012	£1079	£1205	£1250	£1300

wall units (720mm high cabinets)																			
single wall units	260mm	300mm	400mm	450mm	500mm	600mm	double wall units				standard corner wall units	600mm	900mm						
code	W26	W30	W40	W45	W50	W60	code	W70	W80	W90	W100	code	WC60	WC90					
	£259	£285	£301	£346	£359	£400		£510	£532	£601	£623		£488	£615					

wall units (575mm high cabinets)																
single wall units	300mm	400mm	450mm	500mm	600mm	double wall units				800mm	900mm	1000mm	corner wall units	600mm	900mm	
code	W357	W457	W4557	W557	W657	code	W857	W957	W157	code	WC657	WC957				
	£241	£261	£282	£315	£327		£459	£484	£509		£438	£540				

feature wall units													
720 high bi-fold units with Blum Aventos	600mm	800mm	900mm	1000mm	bridging units 360mm high (with Blum Aventos HK-S)				600mm	800mm	900mm	1000mm	
code	WBI60	WBI80	WBI90	WBI10	code	WB63	WB83	WB93	WB13				
	£653	£749	£780	£810		£331	£392	£412	£427				
										note: the back of the loose shelf requires trimming			

feature wall units						appliance doors									
smoked glass wall unit 720mm high	500mm	600mm	reeded glass wall unit 720mm high	500mm	600mm	integrated extractor door	built under fridge / dw / washer door	integrated dishwasher door	semi integrated dishwasher door	boiler door					
code	WG5	WG6	code	WGR5	WGR6	AD60ICH	AD60FD	AD45I	AD60S	BLD9					
	£441	£485		£441	£485										
											450 x 600mm	685 x 600mm	685 x 450mm	570 x 600mm	895 x 600mm
8mm glass shelf	£66	£66	8mm glass shelf	£66	£66	£141	£187	£155	£166	£265					

panels									
end support	wall plant on	tall plant on	small breakfast bar back panel	large universal panel / breakfast bar back panel	breakfast bar / island end panels				
900 x 650 x 19mm	797 x 355 x 19mm	2430 x 650mm	900 x 1200 x 19mm	910 x 2430 x 19mm	685 x 1200 x 19mm	685 x 397 x 19mm	685 x 497 x 19mm	685 x 597 x 19mm	
ESP	PWEP8	PTEP	BBP	LUP	IP612	IP64	IP65	IP66	
									not available in stained colours
painting £216	£148	£533	painting £299	£583	£301	£130	£162	£187	
stained £347*			stained £559*						

trims & accessories											
plinth	universal cornice / pelmet	internal base corner post	external base corner post	touch up paint	tape roll (veneered)	touch up stain pen	wall unit base shelf for canopy extractor				
3000 x 150 x 19mm	3000 x 50 x 28mm	685 x 70 x 18mm	685 x 46 x 46mm	20ml	oak (10m) unfinished		1000 x 310mm				
PL	SQPEL	BCP68	EXCP68	TUP	ET	TUSP	EBSK				
£165	£194	£181	£224	£43	£33	£72	£148				
							comes with Salice touch open fittings				

*note: stained panel available on an 8 week lead time.

price group

three - strato

Price of drawers includes LochAnna Excel soft close drawer boxes. Units supplied with titanium soft closing hinges.

See pages 90 - 97 for handleless profile rail prices.

appliance housings						
	double oven housing unit 2 door (495 & 570 door)	single oven housing unit 2 door (645 & 715 door)	single oven micro housing unit 2 door (450 & 450 door)	50/50 fridge freezer unit	70/30 fridge freezer unit	600mm built under oven housing
	600mm	600mm	600mm	600mm	600mm	Fixed panel
LH Hinge	AH-DOL	AH-SOL	AH-SMWL	AH-F55	AH-F73	BOH6
RH Hinge	AH-DOR	AH-SOR	AH-SMWR			
	£774	£858	£774	£912	£945	£220

larders						
	larder unit 2 door			larder unit 1 door		larder unit with VS TAL Larder pull out
	300mm	500mm	600mm	500mm	600mm	300mm
Code	L3	L5	L6	L5SD	L6SD	LP3
	£741	£925	£1023	£925	£1023	£1493

larders					
	larder drawer tower with excel plus glass drawers 2 door			larder drawer tower with excel plus glass drawers 1 door	
	300mm	500mm	600mm	500mm	600mm
Code	LT3	LT5	LT6	LT5SD	LT6SD
	£1533	£1857	£2003	£1857	£2003

larders								
	larder unit with VS T AL Gate Pro pull out 2 doors		larder unit with VS TAL Gate Pro pull out 1 door		larder unit with VS TAL Gate pull out 2 doors		larder unit with VS TAL Gate pull out 1 door	
	500mm	600mm	500mm	600mm	500mm	600mm	500mm	600mm
Code	LP5T	LP6T	TLP5T	LP6TSD	LP5TS	LP6TS	LP5TSSD	LP6TSSD
	£2060	£2152	£2060	£2152	£1814	£1963	£1814	£1963

highline base units														
base unit with VS SUB pull out	150mm trays	300mm	single base units	150mm	300mm	400mm	450mm	500mm	600mm	double base units	700mm	800mm	900mm	1000mm
code	BP15TY	BP3TY	code	BH15	BH30	BH40	BH45	BH50	BH60	code	BH70	BH80	BH90	BH100
	£447	£733		£275	£356	£406	£431	£456	£512		£642	£707	£750	£802
			base units with pull out bin	300mm	400mm	450mm	500mm	600mm	600mm					
			code	BH3B	BH4B	BH45B	BH5B	BH6B4	BH6B2					
				£707	£819	£849	£880	£1020	£971					

highline corner units												
corner base units 800mm	300mm door	400mm door	450mm door	corner base units 900mm	450mm door	corner base units 1000mm	450mm door	500mm door	600mm door	corner base units 1000mm with VS CORNERSTONE MAXX pull out	500mm door	600mm door
code	BC83	BC84	BC845	code	BC945	code	BC145	BC15	BC16	LH wirework	BCL15L	BCL16L
										RH wirework	BCL15R	BCL16R
											£1641	£1743
	£722	£765	£785	£788	£796	£818	£860			(RH Shown)		soft close as standard

highline corner units										
corner base units 900mm with VS COR FLEX pull out	450mm door	corner base units 1000mm with VS COR FLEX pull out	450mm door	500mm door	600mm door	930L corner base units	930mm	island base units (270mm reduced depth)	500mm	1000mm
code	BCO945	code	BCO145	BCO15	BCO16	code	BCL9	code	BI50	BI10
									£435	£770
	£1749	£1757	£1779	£1821	£1079					see separate tech guide for more info

drawer packs															
3 drawer unit (1 pan)					2 drawer unit (2 pan)					2 drawer unit with internal drawer (1 pan)					
500mm	600mm	800mm	900mm	1000mm	500mm	600mm	800mm	900mm	1000mm	500mm	600mm	800mm	900mm	1000mm	
BD53	BD63	BD83	BD93	BD13	BD52	BD62	BD82	BD92	BD12	BD52I	BD62I	BD82I	BD92I	BD12I	
excel	£792	£881	£1034	£1092	£1170	£652	£739	£893	£956	£1025	£784	£879	£1055	£1124	£1198
leginbox	£1132	£1221	£1374	£1432	£1510	£932	£1019	£1173	£1236	£1305	£1124	£1219	£1395	£1464	£1538



wall units (720mm high cabinets)															
single wall units	260 mm	300 mm	400 mm	450 mm	500 mm	600 mm	double wall units	700 mm	800 mm	900 mm	1000 mm	standard corner wall units	600 mm	900 mm	
code	W26	W30	W40	W45	W50	W60	code	W70	W80	W90	W100	code	WC60	WC90	
	£249	£280	£304	£326	£333	£382		£498	£538	£561	£571		£495	£609	





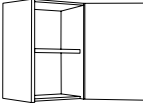
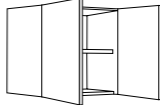
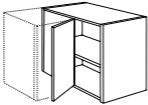

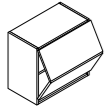
price group
three - strato



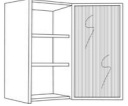

price group
four - elswick



Price of drawers includes LochAnna Excel soft close drawer boxes.
Units supplied with titanium soft closing hinges.
See pages 90 - 97 for handleless profile rail prices.

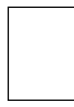

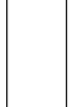
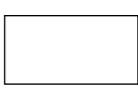
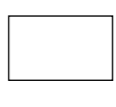
wall units (575mm high cabinets)												
single wall units	300 mm	400 mm	450 mm	500 mm	600 mm	double wall units	800 mm	900 mm	1000 mm	corner wall units	600 mm	900 mm
code	W357	W457	W4557	W557	W657	code	W857	W957	W157	code	WC657	WC957
	£246	£265	£289	£320	£330		£467	£498	£519		£455	£555

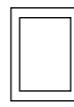
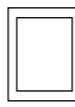
feature wall units										
720 high bi-fold units with Blum Aventos	600 mm	800 mm	900 mm	1000 mm	bridging units 360mm high (with Blum Aventos HK-S)	600 mm	800 mm	900 mm	1000 mm	
code	WBI60	WBI80	WBI90	WBI10	code	WB63	WB83	WB93	WB13	
	Note: the back of the loose shelf requires trimming					£343	£406	£429	£447	
	£677	£777	£814	£850						

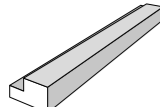
feature wall units					appliance doors					
smoked glass wall unit 720mm high	500 mm	600 mm	reeded glass wall unit 720mm high	500 mm	600 mm	integrated extractor door	built under fridge / dw / washer door	integrated dishwasher door	semi integrated dishwasher door	boiler door
code	WG5	WG6	code	WGR5	WGR6	450 x 600mm	685 x 600mm	685 x 450mm	570 x 600mm	895 x 600mm
	£441	£485		£441	£485					
8mm glass shelf	£66	£66	8mm glass shelf	£66	£66	£152	£308	£244	£169	£267

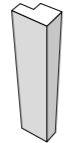
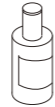
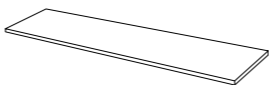
panels							
end support	wall plant on	tall plant on	large universal panel / breakfast bar back panel	breakfast bar / island end panels			
900 x 650 x 19mm	960 x 360 x 19mm	2430 x 650mm	910 x 2430 x 19mm	685 x 1200 x 19mm (plain)	685 x 397 x 19mm (shaker)	685 x 497 x 19mm (shaker)	685 x 597 x 19mm (shaker)
ESP	PWEP9	PTEP	LUP	IP612	IP64	IP65	IP66
							
£179	£179	£364	£463	£370	£224	£266	£308

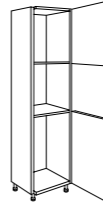
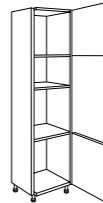
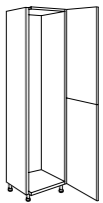
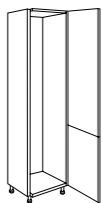
trims & accessories						
plinth	modern cornice / pelmet	internal base corner post	external base corner post	tall feature end post	touch up paint	wall unit base shelf for canopy extractor
3050 x 150 x 18mm	3050 x 60 x 35mm	685 x 70 x 18mm	685 x 46 x 46mm	3050 x 60 x 35mm	20ml	1000 x 310mm
PL	SQPEL	BCP68	EXCP68	FEP	TUP	EBSK
						
£160	£140	£228	£228	£129	£43	£148
comes with Salice touch open fittings						

appliance housings						
	double oven housing unit 2 door (495 & 570 door)	single oven housing unit 2 door (645 & 715 door)	single oven micro housing unit 2 door (450 & 450 door)	50/50 fridge freezer unit	70/30 fridge freezer unit	600mm built under oven housing
	600mm	600mm	600mm	600mm	600mm	Fixed panel
LH Hinge	AH-DOL	AH-SOL	AH-SMWL	AH-F55	AH-F73	BOH6
RH Hinge	AH-DOR	AH-SOR	AH-SMWR			
						
	£860	£845	£796	£928	£896	£215

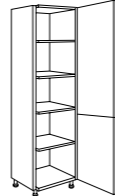
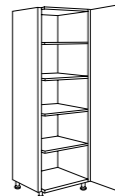
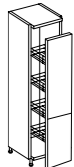
larders						
	larder unit 2 door			larder unit 1 door		larder unit with VS TAL Larder pull out
	300mm	500mm	600mm	500mm	600mm	300mm
Code	L3	L5	L6	L5SD	L6SD	LP3
						
	£764	£874	£974	£874	£974	£1516
comes with 2 reduced depth end panels						

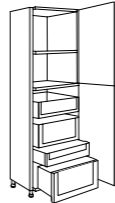
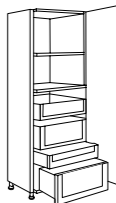
larders					
	larder drawer tower with excel plus glass drawers 2 door			larder drawer tower with excel plus glass drawers 1 door	
	300mm	500mm	600mm	500mm	600mm
Code	LT3	LT5	LT6	LT5SD	LT6SD
					
	£1634	£1806	£1954	£1806	£1954

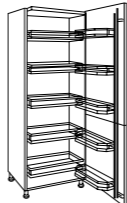
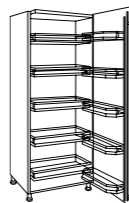
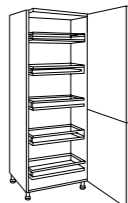
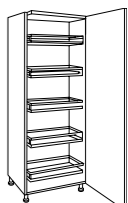
larders								
	larder unit with VS TAL Gate Pro pull out 2 doors		larder unit with VS TAL Gate Pro pull out 1 door		larder unit with VS TAL Gate pull out 2 doors		larder unit with VS TAL Gate pull out 1 door	
	500mm	600mm	500mm	600mm	500mm	600mm	500mm	600mm
Code	LP5T	LP6T	TLP5T	LP6TSD	LP5TS	LP6TS	LP5TSSD	LP6TSSD
								
	£2009	£2103	£2009	£2103	£1763	£1914	£1763	£1914

price group

four - elswick



Anodised Aluminium rail



Anthracite rail



Anodised Aluminium rail

Rail Colours

Choice is everything and with LochAnna FORM you can personalise your door colour with the rail finishes that suits you best.

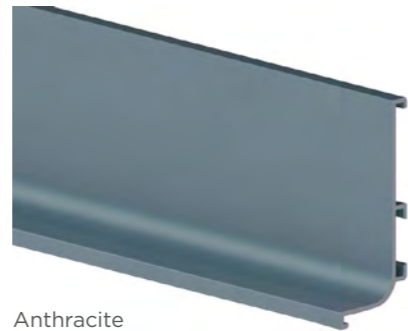

Anthracite



Anodised Aluminium

Horizontal Base Rails

The rails that fit at the top and mid position on your base cabinets.



Top rail

- Used for the underside of the worktop above top drawers and full height doors
- Dimensions 3900 x 57.5 x 24mm

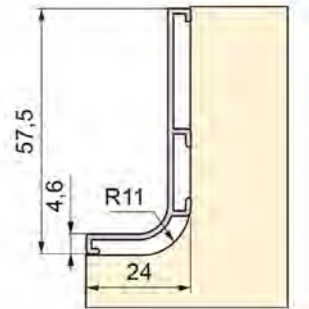

TOP RAIL	LENGTH	CODE	PRICE
Anthracite	3.9m	BRTOP-AT	£87
Anodised Aluminium	3.9m	BRTOP-AN	£87

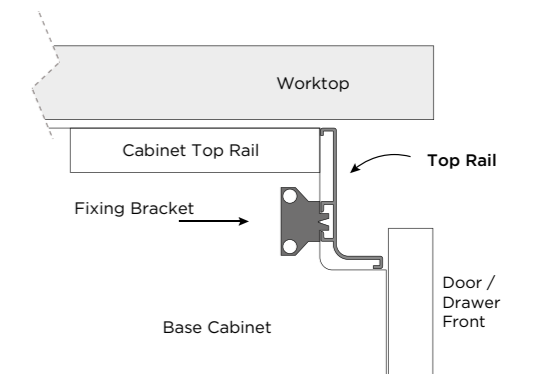

Top tip: The fixing brackets should be knocked into the pre-drilled holes in the cabinet sides using a rubber mallet before the cabinet is assembled

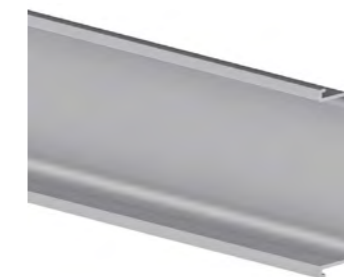

Mid rail

- Used between drawers, mid-way down the base cabinet
- Dimensions 2350 x 70 x 24mm

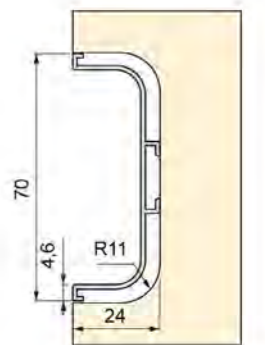

MID RAIL	LENGTH	CODE	PRICE
Anthracite	2.35m	BRMID-AT	£102
Anodised Aluminium	2.35m	BRMID-AN	£102

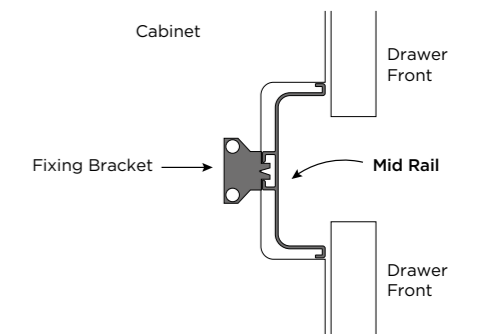

Top tip: The fixing brackets should be knocked into the pre-drilled holes in the cabinet sides using a rubber mallet before the cabinet is assembled

Base Rail Fittings

Fixing brackets (top and mid rail)

The rails are fixed using the bracket below.

Simply knock the fitting into place in the pre-drilled 8mm holes in the cabinet using a rubber mallet. This should be done before the cabinet is assembled. Once the rail is offered up to the bracket the lever should be turned 90 degrees to lock the rail in place.

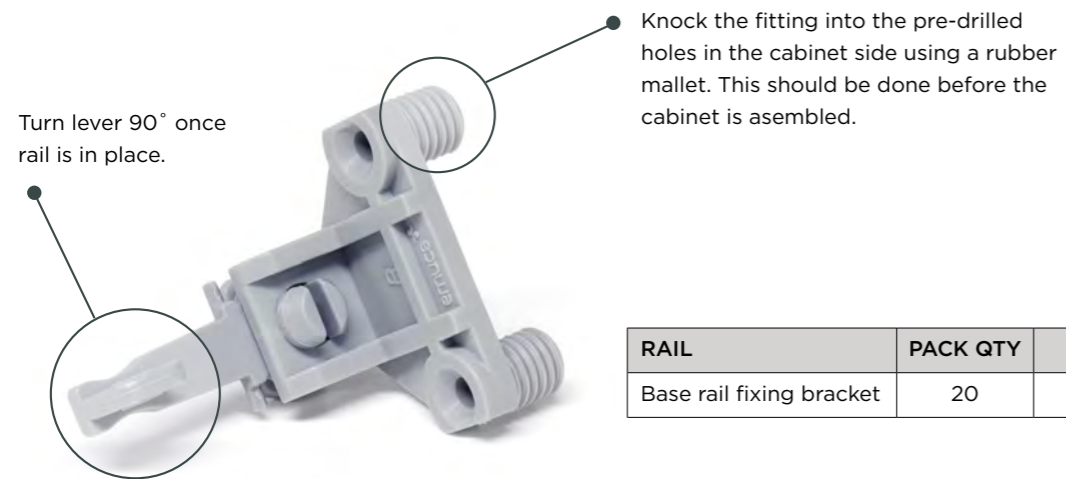

RAIL	PACK QTY	CODE	PRICE
Base rail fixing bracket	20	BRFIT	£58

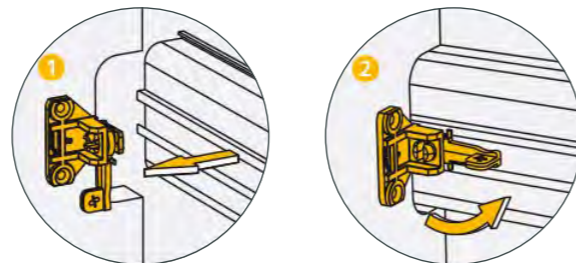
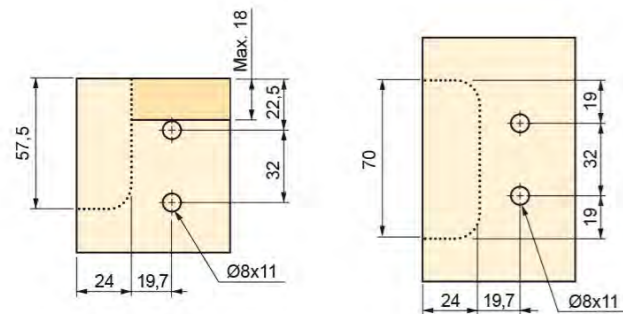

End caps

Made from complementary plastic. Available for top rail and mid rails the pack includes full rail caps and open trim caps.

Top rail kit - Pack includes:

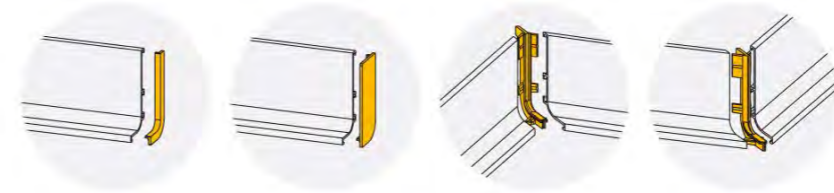

Mid rail kit - Pack includes:

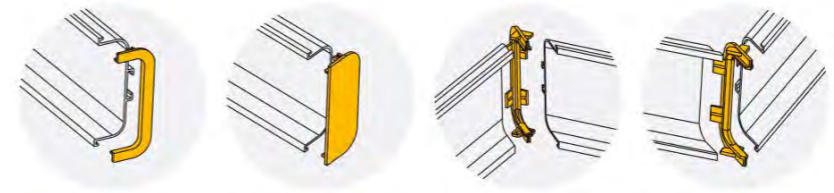

TOP RAIL CAP KIT	QTY	CODE	PRICE
Anthracite	1 pack	BRCKT-AT	£16
Anodised Aluminium	1 pack	BRCKT-AN	£16

MID RAIL CAP KIT	QTY	CODE	PRICE
Anthracite	1 pack	BRCKM-AT	£16
Anodised Aluminium	1 pack	BRCKM-AN	£16

Top rail corner

Made from robust aluminium. Use the grub screws to secure into place.

Internal connector block

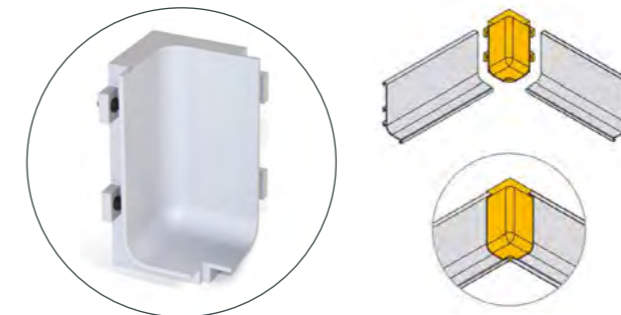

External connector block

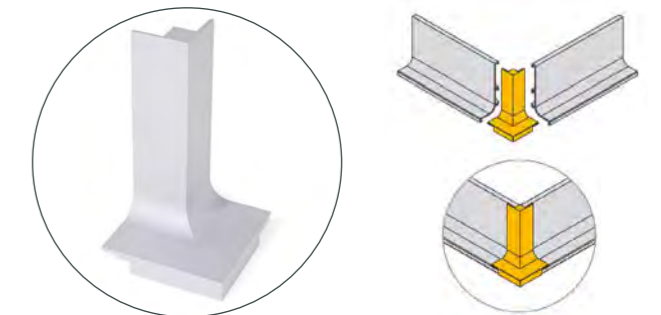

INTERNAL BLOCK	QTY	CODE	PRICE
Anthracite	1	BRINTC-AT	£66
Anodised Aluminium	1	BRINTC-AN	£66

EXTERNAL BLOCK	QTY	CODE	PRICE
Anthracite	1	BREXTC-AT	£66
Anodised Aluminium	1	BREXTC-AN	£66

N.B.

Mid rail corner fittings are not available - when a drawer pack meets a corner post, end caps will be needed (see above).

Rails - Wall Units

Wall rails

Sold in 2.35m lengths, the rail can be cut on site and inserted into the pre-routed groove in the wall unit base shelf. Use a bead of silicone or contact adhesive to secure the rail in place.

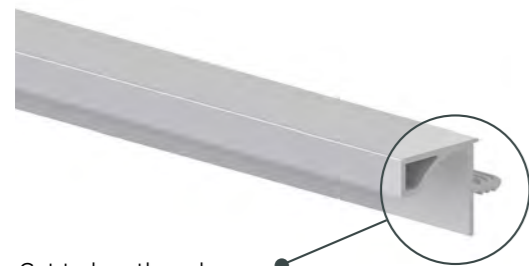
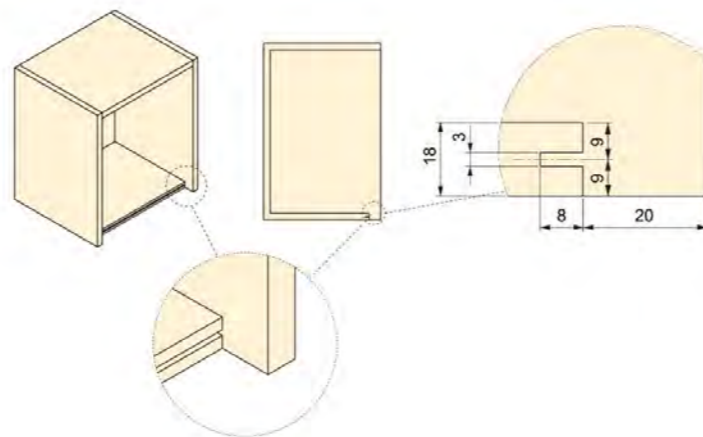
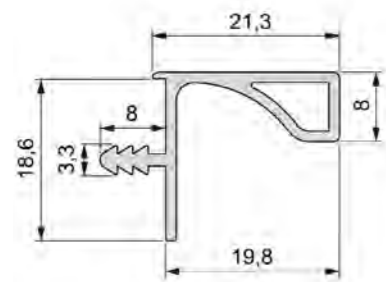

Cut to length and use silicone / adhesive to secure in place.

WALL UNIT RAIL	LENGTH	CODE	PRICE
Anthracite	2.35m	WRAIL-AT	£52
Anodised Aluminium	2.35m	WRAIL-AN	£52

Extractor unit shelf kit

Where an integrated extractor hood is being installed into a 360/570mm wall unit it might be necessary to replace the reduced depth shelf with a full depth shelf.

The shelf is available 1000mm wide, so may require cutting down on site. The shelf is supplied with a double door touch open hinge kit.

N.B. Hinges supplied with the touch open kit are nickel, not titanium.

SHELF KIT	LENGTH	CODE	PRICE
Wall unit base shelf kit	1.0m	EBSK	£148

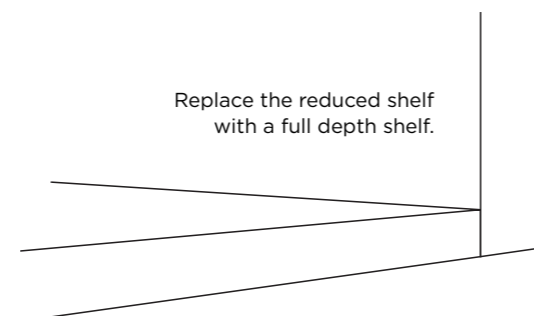

Vertical Rails - Tall Units

Intermediate rails

- Used between tall units where two opening doors meet
- Secured in place using 25mm screws through the cabinet sides and into the profile
- Used in conjunction with the 30mm spacer, which is fixed at the back between the cabinets
- Panels are pre-cut to allow for the rail (see below for handing information)

INTERMEDIATE RAIL	LENGTH	CODE	PRICE
Anthracite	2.35m	VRINT-AT	£87
Anodised Aluminium	2.35m	VRINT-AN	£87
Spacer (single)	30mm	TUSPC	£9

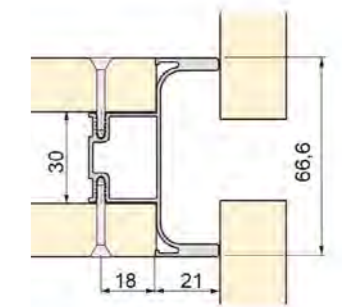

Spacer

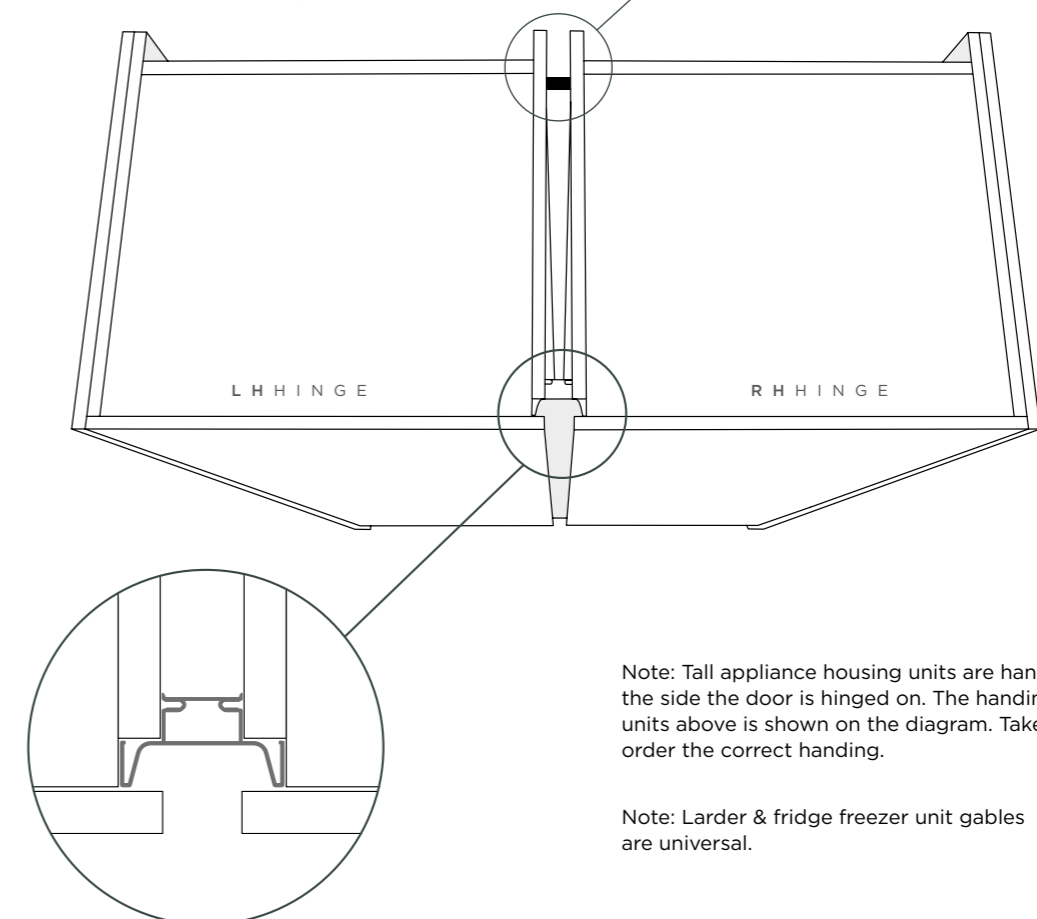
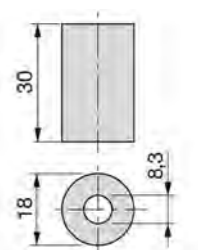
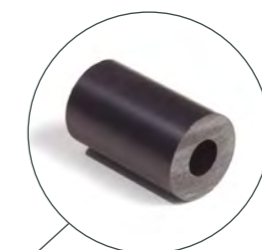

Note: Tall appliance housing units are handed by the side the door is hinged on. The handing of the units above is shown on the diagram. Take care to order the correct handing.

Note: Larder & fridge freezer unit gables are universal.

Vertical Rails - Tall Units

Lateral rails

- Used on tall units where just one door might be opening or at the side/end of a tall unit run
- Secured in place using 25mm screws through the cabinet sides and into the profile
- Used in conjunction with the 30mm spacer, which is fixed at the back between the cabinets
- Panels are pre-cut to allow for the rail (see below for handing information)

LATERAL RAIL	LENGTH	CODE	PRICE
Anthracite	2.35m	VRLAT-AT	£73
Anodised Aluminium	2.35m	VRLAT-AN	£73
Spacer (single)	30mm	TUSPC	£9

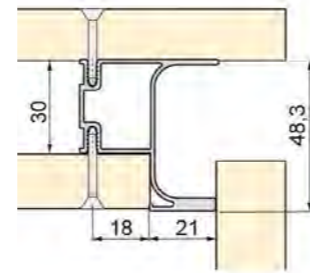

Spacer

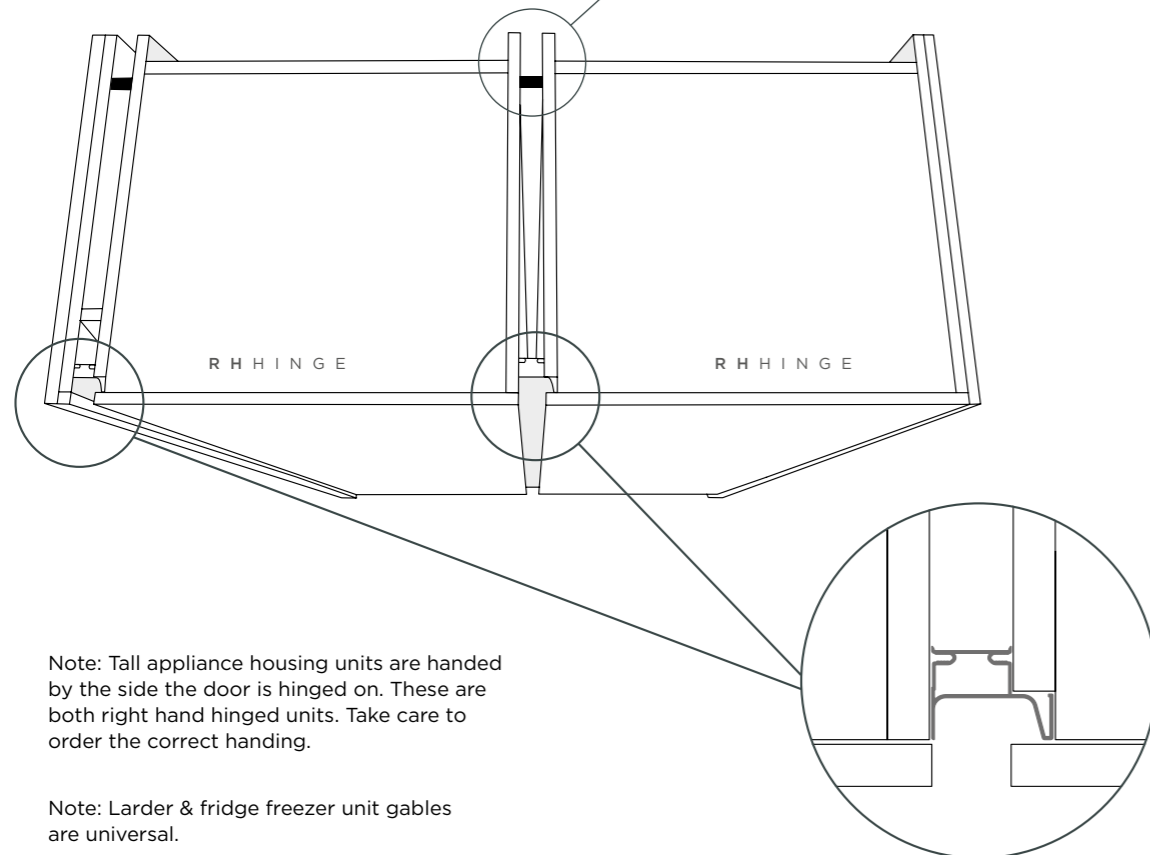
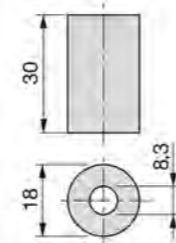
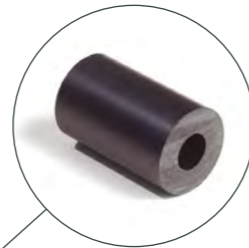

Note: Tall appliance housing units are handed by the side the door is hinged on. These are both right hand hinged units. Take care to order the correct handing.

Note: Larder & fridge freezer unit gables are universal.

Single Oven Profile Rails

For use in a tall appliance housing

- This rail is designed to fill the gap behind built in ovens. Only required on one side - the side that overhangs the rail
- Secured using 12mm screws, the rail must be fixed before the oven is installed
- For tall ovens and combi installations more than one rail per side is required



Appliance filler rail

Appliance filler rail shown mounted behind appliance.

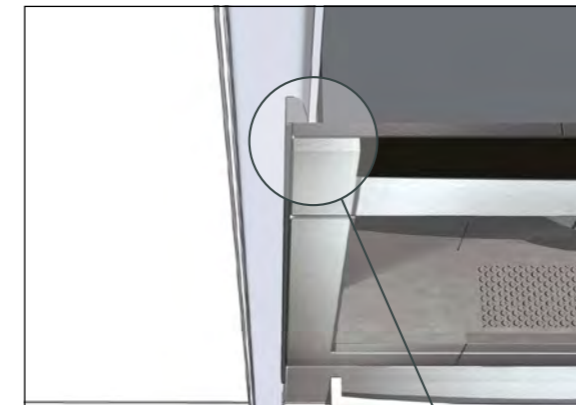

Screw-fix into cabinet gable using 3 No. 4x12mm screws before installation of the appliance.

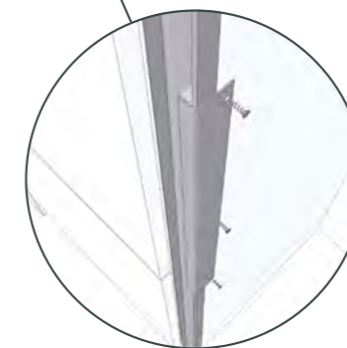

Fitting detail

Designed to match both vertical profiles for a seamless look and screw-fixed into the cabinet.

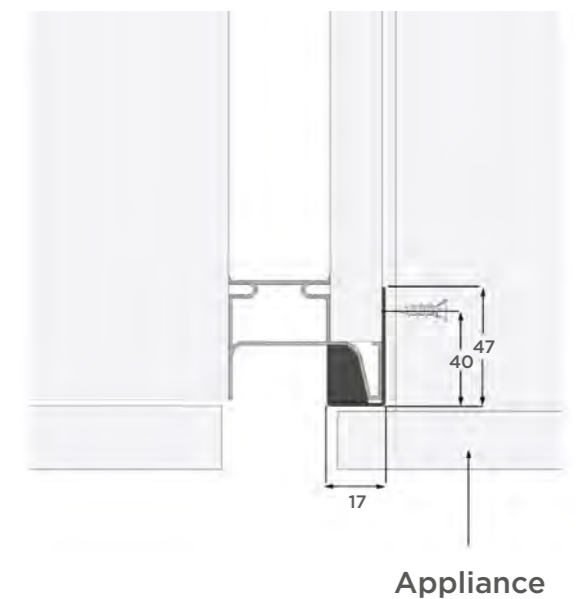

Appliance

OVEN PROFILE RAIL	LENGTH	CODE	PRICE
Anthracite	580mm	OPR-AT	£58
Anodised Aluminium	580mm	OPR-AN	£58

Tips

- It is possible to drill through the trim if the appliance requires a screw-fixing into the cabinet.

Solutions Panels & Open Shelving

A range of accessory panels in three realistic woodgrains. Offering you a natural contrast to modern door finishes, whether your kitchen choice is matt, gloss, cream, mussel, white or any of the shades of grey, you can include Solutions. Create splashbacks or open shelving on site using panels, or order your open shelving pre-made to your required size using our Made to Measure service.



Shelving

Use Solutions panels to create practical but fashionable shelving to complement your kitchen. Shelving can be the answer to an unusual sized space or a challenging ceiling pitch.



Splashbacks

An effective and modern alternative to tiles. Simple to install and you'll enjoy the benefit of Solutions for years to come.

Finishes available



Solutions Natural Oak



Solutions Tobacco Oak



Solutions White Oak

- Solutions Large Universal Panel 2.4m x 900mm (18mm) **£264**
- Solutions End Support Panel 900 x 600mm (18mm) **£86**
- Solutions 18mm edge tape for panels (10m) **£30**



Made to Measure Open Shelving

You can order Made to Measure open shelving units in our three Solutions finishes. Simply give us the height and width you'd like and we'll make it to your measurements.

- Pricing is calculated using one size down in the matrix. For example if you need a unit 1255mm high x 350mm wide, you will pay **£309** which is the price for 900mm x 300mm.
- Units are 330mm deep, with 10mm service void.
- The price matrix shows how many shelves are supplied with each size.
- 300mm wine racks will have two rows of bottle spaces.
- Wine racks can be fitted vertically or horizontally.

Open Units						
		Height (mm)				
No. of Fixed Shelves		0	0	0	0	1
No. of Loose Shelves		0	0	1	2	3
		286	360	720	900	1967
Width (mm)	150	£255	£255	£281	£309	£566
	300	£255	£255	£281	£309	£566
	400	£255	£255	£281	£309	£566
	500	£255	£255	£281	£309	£566
	600	£255	£255	£281	£309	£618
	700	£281	£281	£309	£330	
	800	£281	£281	£309	£330	
	900	£281	£281	£309	£330	
	1000	£281	£281	£309	£330	
	1200	£309	£309			

Wine Racks					
		Height (mm)			
		286	720	900	1967
Width (mm)	150	£255	£281	£309	£330
	300	£255	£281	£309	£566

Lead Time is five weeks from order.

Storage solutions

Vauth Sagel have been delivering German engineering excellence for over 50 years. Their range of wirework boasts integrated soft close, a 10 year warranty and superior design and functionality.

larder storage



TAL Larder Pull Out.



TAL GATE Larder Pull Out



TAL GATE Pro Larder Pull Out

base unit storage

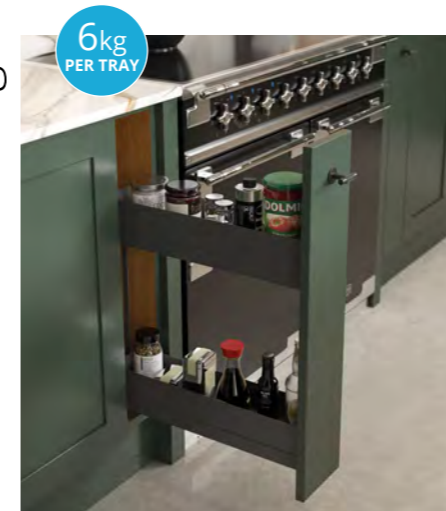

SUB Slim Base Pull Out.



SUB Base Pull Out.

corner unit storage



CORNERSTONE Maxx Pull Out for 1000mm Corner Base Unit



COR FLEX Corner Pull Out for 900mm & 1000mm Corner Base Units



Optional extension pole available to fit four trays in a blind larder **£10**

drawer options

LochAnna furniture is supplied as standard with Excel soft close drawers, which can be upgraded to Blum Legrabox in Carbon Black or Oak Dovetail. We have a fantastic range of accessories to choose from and tailor your storage to your needs.

excel drawer



LochAnna Excel drawer with 30kg load bearing (standard)

blum legrabox



Blum Legrabox Carbon Black drawer with 40kg load bearing capacity (option). Upgrade per drawer £100 standard / £140 pan

oak dovetail



LochAnna Solid Oak Dovetail drawer with 40kg load bearing capacity (option). Upgrade per drawer £110 standard / £150 pan

excel drawer options



Excel drawer
Supplied as standard



Excel Internal Drawer
Note: requires 155° hinges on doored units - £19 per hinge

300mm	£143	800mm	£193
400mm	£155	900mm	£201
500mm	£168	1000mm	£206
600mm	£176		



Excel Internal Pan Drawer
Note: requires 155° hinges - £19 per hinge

300mm	£157
500mm	£183
600mm	£196



Excel Plus Glass Internal Drawer
Note: requires 155° hinges - £19 per hinge

Standard	Pan
300mm £203	300mm £320
400mm £219	400mm £338
500mm £219	500mm £338
600mm £238	600mm £352
800mm £286	800mm £405
900mm £286	900mm £422
1000mm £304	1000mm £438

excel drawer cutlery trays



Plastic Cutlery Tray - £37 each
Compatible with Excel drawers only. Note: will require trimming on site to fit into an internal drawer

Size	Excel	Size	Excel
400mm	CT4-GG	800mm	CT8-GG
500mm	CT5-GG	900mm	CT9-GG
600mm	CT6-GG	1000mm	CT10-GG

Note: not compatible with Durham drawers.



Beech Cutlery Tray
Compatible with Excel drawers and internal drawers, use the relevant code to order. Trays available for Durham Excel drawers - add DU to the end of the code to order

Size	Price	Standard drawer	
		Excel	Internal drawer
500mm	£180	CT5-BH	CT5-BHI
600mm	£205	CT6-BH	CT6-BHI
800mm	£246	CT8-BH	CT8-BHI
900mm	£266	CT9-BH	CT9-BHI
1000mm	£297	CT10-BH	CT10-BHI

excel drawer beech cutlery tray inserts

Compatible with plastic trays 800mm, 900mm & 1000mm wide. 800mm trays have one space for an insert, 900 & 1000mm have two.



Our beech cutlery trays & inserts feature beautiful LochAnna branding.

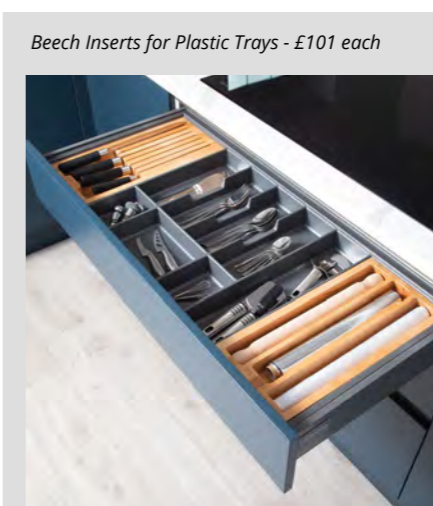

Beech Inserts for Plastic Trays - £101 each

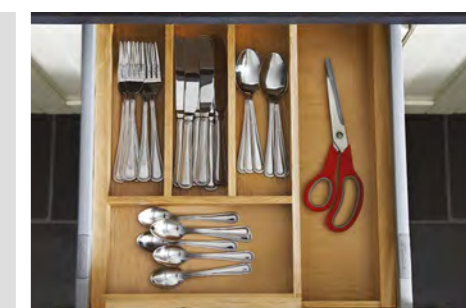

Beech Adjustable Cutlery Tray
Note: only compatible with Excel drawers, does not fit into internal drawers

400 - 600mm	£122	Note: 400-600mm size will fit in 450, 500 & 600mm Durham Excel drawers
800 - 1000mm	£152	Note: 800-1000mm size will fit in 800 & 1000mm Durham Excel drawers



Spice tray insert

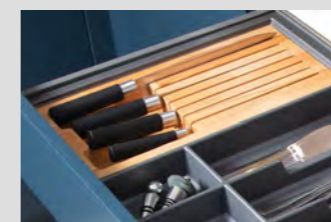

Knife block insert



Foil/film holder insert



Chopping board insert

excel pan drawer accessories



Beech Plate Rack Insert
Compatible with Excel pan drawers only

Size	Price	Excel
600mm	£195	PR6-BH
800mm	£230	PR8-BH
900mm	£257	PR9-BH
1000mm	£297	PR10-BH

Note: not compatible with Durham drawers.



Beech Pan & Plate Stacker Insert
Compatible with Excel pan drawers only

Size	Price	Excel
600mm	£246	PS6-BH
800mm	£286	PS8-BH
900mm	£317	PS9-BH
1000mm	£347	PS10-BH

Note: not compatible with Durham drawers.



Excel Pan Drawer Glass Sides - £69 per pair

legrabox AMBIA-LINE drawer inserts

Organise the storage in your Blum Legrabox drawers perfectly with the AMBIA-LINE drawer insert kits. All kits are made up to suit the drawer widths specified – but you can mix and match components yourself from the range at the bottom of the page. All of our Legrabox drawers come as standard with non-slip matting already fitted.

Cutlery Insert Kits



Cutlery Tray for 400-600mm drawers
£185



Cutlery Tray & Insert for 600-800mm drawers
£237



Cutlery Tray & Insert for 800-1000mm drawers
£314

Utensil Insert Kits



Utensil Inserts for 400-600mm drawers
£115



Utensil Inserts for 600-800mm drawers
£166



Utensil Inserts for 800-1000mm drawers
£166

Pan Drawer Frame Insert Kits

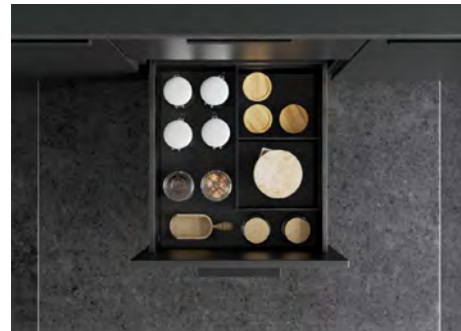

Frame Insert Kit for 400-600mm pan drawers
£110



Frame Insert Kit for 600-800mm pan drawers
£220



Frame Insert Kit for 800-1000mm pan drawers
£220

Cutlery Drawer Components



Cutlery Tray 300x450mm
£185



Narrow Insert 100x450mm
£52



Wide Insert 200x450mm
£63

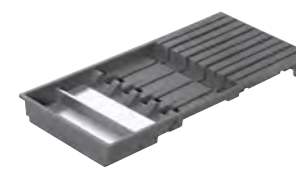

Knife Holder 200x450mm
£66



Spice Holder 200x450mm
£98



Foil & Film Dispenser 200x450mm
£157

Pan Drawer Components



Frame Kit 218x450mm
£110



Cross Divider Kit
400-600mm drawers £22
600-1000mm drawers £34

oak options

Note: not compatible with Durham drawer units



Oak Dovetail Drawer
Upgrade £110 per standard, £150 per pan drawer



Oak Dovetail Internal Drawer
Note: requires 155° hinges - £19 per hinge



Oak Cutlery Inserts
Bespoke made for our Oak Dovetail drawers

Standard (90mm high)	Pan (180mm high)
600mm £275	600mm £321
800mm £292	800mm £339
900mm £300	900mm £351
1000mm £305	1000mm £356

500mm* £174	Inserts for oak internal drawers
600mm £173	600mm £256
800mm £189	800mm £280
900mm £217	900mm £280
1000mm £217	1000mm £286

*Note: 500mm not available for Durham

bins

Our fantastic range of eco-bins have soft close Grass runners and attach to the door of the unit to be true pullout bins. With a practical and sturdy metal shelf to store your bin bags or cleaning materials.



300 Eco bin (35L) 1 x 35L. Suits 300mm base unit
£365



400 Eco bin (64L) 2 x 32L. Suits 400mm base unit
£427



450 Eco bin (70L) 2 x 35L. Suits 450mm base unit
£432



500 Eco bin (70L) 2 x 35L. Suits 500mm base unit
£438



600 Eco bin (80L) 2 x 40L. Suits 600mm base unit
£473.



600 Eco bin (86L) 2 x 35L, 2 x 8L.
Suits 600mm base unit. £522

accessories

European trends are showing us that modern sleek kitchens benefit from the introduction of carefully designed accessories. Those finishing touches can make all the difference to your design.



Box Shelves

Available in 600mm & 900mm widths and can be joined to create interesting designs and storage solutions – use panels in matching or contrasting door colours to create the shelf bases.

Colours available: Black.

Size: 600mm & 900mm wide, 330mm deep & 360mm high.

600mm - £297 900mm - £311

Note: Price includes frame & fittings for one box shelf only, inlay shelves must be cut from accessory panels and edged. These must be purchased separately.

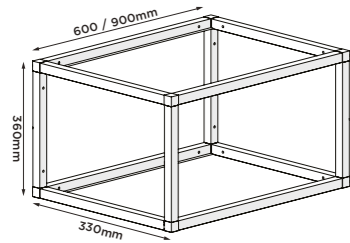

Box shelves come as a single frame kit. They can be joined using the fittings shown here.

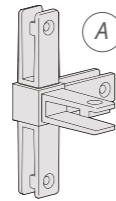

A 4-way connector
Pack of 4: £77

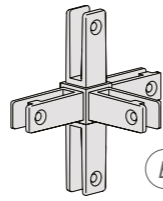

B 5-way connector
Pack of 2: £55

Aluminium frame doors

Our black aluminium frame doors are available in 500mm and 600mm wide in either smoked or reeded glass. We've improved the design to work perfectly with our cabinets and hinges. Each door comes with a slimline self-adhesive matching black handle which can be fitted for LochAnna kitchens or left off for FORM true handleless. See the price group pages for unit pricing.



Smoked glass



Reeded glass

Door Stays

Blum Aventos HK-XS



Supplied as standard on all bridging / flap doors in price groups 1 & 2. One mechanism is supplied on units 600-800mm wide, two on 900-1000mm wide.

Blum Aventos HK-S



Supplied as standard on all bridging / flap doors in price group 3 onwards.



Industrial Breakfast Bar Support

Available in two heights, 870mm for breakfast bars and 720mm for dining height, this robust and stylish leg will offer a lasting design feature for a dining kitchen.

Both are 700mm wide, fabricated from 25mm x 75mm box steel.

720mm - £249 each

870mm - £249 each



Door Jointing Plates



43mm £5 each
105mm £5 each (cannot be used on Profile doors)



Glass Shelf

500mm (4mm thick) £53
500 / 600mm (8mm thick) £70
1000mm (8mm thick) £101

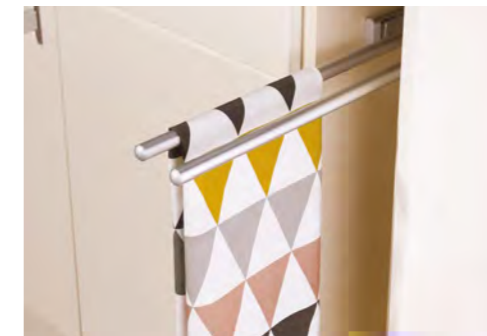

Telescopic Towel Rail
Aluminium effect £38



Soft Close Pull Out Baskets available in 500mm £75 & 600mm £75



Base Cabinet Liners for Water Protection

500mm £30
600/800/900/1000mm £46



Breakfast Bar Leg
Chrome £68



Wicker basket

Available as an optional extra, these hard-wearing baskets can be fitted into any of our cabinets, but look especially good in the top central section of our Butler's Pantry, as shown here. Measurements (mm): 195H x 220W x 220D - £83 each

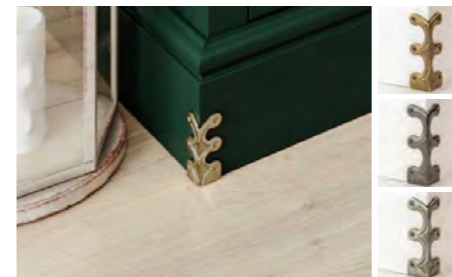

Skirting Plinth Skiffers

Available in three colours Antique Brass, Bronze and Pewter. Size: 75mm x 30mm x 30mm

Supplied with 6 coordinating screws £29 each



Hole Cover Caps

5mm (pack of 50) or 35mm (pack of 20) available in white, light brown or grey £9

14mm self adhesive (sheet of 25) available in White, Stone Grey, Oak, Grey Linen & Anthracite Linen £9



Plinth Connector

(1000mm lengths) Anodised matt (can be painted to match plinth if fitting a painted kitchen) - One length does 5-6 plinth corners.

16mm £34
18mm £34
19mm £34



Fitter's panel (cabinet material) - 2400 x 630mm £125

PRICE GROUPS

PRICE GROUP 1



DEVLIN

Matt foil wrapped 18mm MDF door, complementary colour reverse

PRICE GROUP 1



GRECO

Edged 18mm MFC door, over lacquered, white reverse (Dust Grey doors & panels have a grey reverse)

BUILT TO LAST



QUALITY CABINET

- Our kitchens are supplied on a quality 18mm white cabinet
- Soft close hinges as standard
- Ready assembled available

PRICE GROUP 2



MULLAN

Matt foil wrapped 18mm MDF door, routed centre panel, complementary colour reverse

PRICE GROUP 3



VALLO

Painted 19mm MDF J pull door, double drilled for hinges, white reverse



EXCEL DRAWER BOX

- Soft close
- Twin walled
- 30kg load bearing capacity



WELCOME

Our kitchens do not compromise on quality and value. Using the very best in manufacturing techniques we are able to create a beautiful mix of colour, size and finish. Our larders and appliance housings are available with optional complementary coloured sides, saving you money on cladding panels. We offer soft close drawer boxes and hinges as standard, plus a choice of handles, so you can tailor your kitchen to your taste and budget.

Highline Base Units																										
Base Pull Outs				Single Base Units																						
150mm trays	150mm towel rail	300mm trays	Price	150mm	300mm	300mm + Eco Bin	350mm	400mm	400mm + Eco Bin	450mm	500mm	600mm	600mm + Eco Bin													
														BP15TY	BP15TW	BP3TY	BH15S	BH30S	BH3BS	BH35S	BH40S	BH4BS	BH45S	BH50S	BH60S	BH6BS
														Price	Price	Price	Price	Price	Price	Price	Price	Price	Price	Price	Price	Price
PG1	£304	£306	£489	PG1	£164	£170	£330	£173	£181	£399	£188	£193	£209	£656												
PG2	£305	£307	£491	PG2	£165	£172	£332	£180	£184	£402	£190	£195	£212	£659												
PG3	£305	£307	£506	PG3	£165	£187	£347	£194	£203	£421	£216	£222	£249	£696												

Highline Base Units																								
Double Base Units				Corner Base Units 800mm			Corner Base Units 900mm		Corner Base Units 1000mm															
700mm	800mm	900mm	1000mm	300mm Door	400mm Door	450mm Door	450mm Door	450mm Door	500mm Door	600mm Door	Price	Price	Price											
														BH70S	BH80S	BH90S	BH100S	BC83S	BC84S	BC845S	BC945S	BC145S	BC15S	BC16S
														Price	Price	Price	Price	Price	Price	Price	Price	Price	Price	
PG1	£275	£290	£299	£310	PG1	£302	£309	£312	PG1	£315	PG1	£320	£323	£328										
PG2	£289	£296	£303	£314	PG2	£305	£313	£315	PG2	£318	PG2	£323	£326	£332										
PG3	£317	£334	£355	£368	PG3	£345	£357	£366	PG3	£369	PG3	£374	£378	£394										

Highline Base Units											
Corner Base Units 1000mm with Le Mans			Corner Base Units 1000mm with Magic Corner			Corner Base Units 800mm with Corner Optimiser		Corner Base Units 900mm with Corner Optimiser			
LH/RH (RH Shown)	500mm door	600mm door	LH/RH (RH Shown)	500mm door	600mm door	400mm door	450mm door	Price	Price		
	BCL15L/R	BCL16L/R		BCM15L/R	BCM16L/R					BCO84S	BCO945S
	Price	Price		Price	Price					Price	Price
PG1	£1,039	£1,095	PG1	£1,060	£1,065	PG1	£890	PG1	£896		
PG2	£1,042	£1,099	PG2	£1,063	£1,069	PG2	£894	PG2	£899		
PG3	£1,094	£1,161	PG3	£1,115	£1,131	PG3	£938	PG3	£950		

Highline Base Units								Feature Base Units								
Corner Base Units 1000mm with Corner Optimiser				950L Corner Base Units		950L Corner Base Units with 3/4 Carousel		Belfast Sink Unit (requires customisation)								
450mm Door	500mm Door	600mm Door	Price	950mm Door	Price	950mm	Price	495mm High Door	450mm High Door							
										BCO145S	BCO15S	BCO16S	BCL9S	BCL9S	BSU6495S	BSU6450S
										Price	Price	Price	Price	Price	Price	Price
PG1	£901	£904	£909	PG1	£444	PG1	£869	PG1	£198	£191						
PG2	£904	£907	£913	PG2	£448	PG2	£873	PG2	£201	£193						
PG3	£955	£959	£975	PG3	£533	PG3	£958	PG3	£226	£219						

Drawer Packs																	
4 Drawer Units			3 Drawer Units				2 Drawer Units										
500mm	Price	Price	500mm	600mm	800mm	900mm	1000mm	600mm	900mm								
										BD54S	BD53S	BD63S	BD83S	BD93S	BD13S	BD62S	BD92S
										Price	Price	Price	Price	Price	Price	Price	Price
PG1	£448	PG1	£384	£404	£484	£491	£525	PG1	£326	£401							
PG2	£455	PG2	£388	£409	£491	£497	£531	PG2	£330	£403							
PG3	£474	PG3	£416	£441	£516	£532	£581	PG3	£368	£457							

* Note: An additional hinge hole must be cut 48mm from the bottom of the 400mm door by the installer when fitted with an 800 Optimiser

Wall Units - 720mm High													
Tall Single Wall Units								Double Wall Units					
	150mm	300mm	350mm	400mm	450mm	500mm	600mm		700mm	800mm	900mm	1000mm	
	W15S	W30S	W35S	W40S	W45S	W50S	W60S		W70S	W80S	W90S	W100S	
	Price	Price	Price	Price	Price	Price	Price		Price	Price	Price	Price	Price
PG1	£150	£156	£160	£167	£174	£182	£192	PG1	£261	£278	£287	£297	
PG2	£151	£158	£167	£170	£176	£184	£195	PG2	£275	£284	£291	£301	
PG3	£151	£173	£181	£189	£202	£211	£232	PG3	£303	£322	£343	£355	

Wall Units - 900mm High													
Single Wall Units						Tall Double Wall Units				Tall Corner Wall Units			
	300mm	400mm	450mm	500mm	600mm		800mm	900mm	1000mm			600mm	900mm
	TW30S	TW40S	TW45S	TW50S	TW60S		TW80S	TW90S	TW100S			TWC6S	TWC9S
	Price	Price	Price	Price	Price		Price	Price	Price	Price		Price	Price
PG1	£176	£180	£194	£202	£218	PG1	£308	£317	£327		PG1	£233	£289
PG2	£178	£197	£196	£204	£220	PG2	£314	£321	£331		PG2	£235	£291
PG3	£193	£201	£222	£231	£263	PG3	£352	£373	£385		PG3	£250	£334

Corner Wall Units - 720mm High														
Standard Corner Wall Units							L Shape Corner Wall Unit							
	600mm			900mm					650mm					
	WC6S			WC9S					WCL65S					
	Price			Price					Price					
PG1	£210			£260				PG1						£347
PG2	£214			£265				PG2						£351
PG3	£227			£300				PG3						£428

Feature Wall Units													
Microwave Wall Unit - 720mm High (requires customisation)		Boiler Unit 900mm High		Bi-Fold Units - 720mm High			Bridging Units 285mm High						
	600mm		600mm Door		600mm	900mm		600mm	800mm	900mm	1000mm		
	WM60S		WBHUS		WB160	WB190		WB62S	WB82S	WB92S	WB12S		
	Price		Price		Price	Price		Price	Price	Price	Price	Price	
PG1	£205	PG1	£228	PG1	£469	£538	PG1	£159	£197	£206	£216		
PG2	£208	PG2	£230	PG2	£473	£540	PG2	£161	£200	£208	£218		
PG3	£223	PG3	£273	PG3	£509	£592	PG3	£176	£211	£224	£239		

Appliance Housings (Available with White MFC 1967mm or Complementary coloured 2140mm side panels. Drawings shown below are with complementary sides)																	
Single Oven Housing Unit 2 door		Single Oven Housing Unit 1 Drawer		Single Oven Housing Unit 2 Drawer		Single Oven Housing Unit 3 Drawer		Single Oven / Microwave Housing Unit		Single Oven / Microwave Housing Unit 2 Drawer							
	600mm		600mm		600mm		600mm		600mm		600mm						
	AH-SOW		AH-SO		AH-SO1DW		AH-SO1DS		AH-SO2DW		AH-SO2DS	AH-SO3DW	AH-SO3DS	AH-SMWW	AH-SMWS	AH-SM2DW	AH-SM2DS
	Price		Price		Price		Price		Price		Price	Price	Price	Price	Price	Price	
PG1	£604	£675	PG1	£675	£746	PG1	£717	£788	PG1	£790	£861	PG1	£628	£699	PG1	£744	£815
PG2	£610	£681	PG2	£682	£753	PG2	£724	£795	PG2	£798	£869	PG2	£633	£704	PG2	£750	£821
PG3	£684	£736	PG3	£746	£798	PG3	£795	£847	PG3	£863	£915	PG3	£685	£737	PG3	£793	£845

Extra Tall Appliance Housings (Available with White MFC 2148mm sides only)													
Tall 50/50 Fridge Freezer Housing		Tall 70/30 Fridge Freezer Housing		Tall Double Oven Housing		Tall Double Oven Housing 2 Drawer		Tall Single Oven Housing		Tall Single Oven Housing 2 Drawers		Tall Single Oven & Microwave Housing 2 Door	
	600mm		600mm		600mm		600mm		600mm		600mm		600mm
	TAH-F55W		TAH-F73W		TAH-DOW		TAH-DO2DW		TAH-SOW		TAH-SO2DW		TAH-SMWW
	Price		Price		Price		Price		Price		Price		
PG1	£645	PG1	£601	PG1	£639	PG1	£752	PG1	£650	PG1	£765	PG1	£667
PG2	£650	PG2	£605	PG2	£646	PG2	£760	PG2	£657	PG2	£773	PG2	£672
PG3	£762	PG3	£711	PG3	£712	PG3	£819	PG3	£731	PG3	£848	PG3	£724

Appliance Housings (Available with White MFC 1967mm or Complementary coloured 2140mm side panels. Drawings shown below are with complementary sides)																
Built Under Oven Housing		50/50 Fridge Freezer Housing		70/30 Fridge Freezer Housing		Double Oven Housing		Double Oven Housing Unit 2 Drawer		Double Oven / Microwave Housing Unit 1 Drawer						
	600mm		600mm		600mm		600mm		600mm		600mm					
	BOH6		AH-F55W		AH-F55		AH-F73W		AH-F73		AH-DOW	AH-DOS	AH-DO2DW	AH-DO2DS	AH-DMWW	AH-DMWS
	Price		Price		Price		Price		Price		Price	Price	Price	Price		
PG1	£145	PG1	£564	£635	PG1	£554	£625	PG1	£587	£658	PG1	£704	£775	PG1	£667	£738
PG2	£146	PG2	£570	£641	PG2	£560	£631	PG2	£591	£662	PG2	£711	£782	PG2	£672	£743
PG3	£146	PG3	£674	£726	PG3	£666	£718	PG3	£643	£695	PG3	£766	£818	PG3	£702	£754

Larder Units (Available with White MFC 1967mm or Complementary coloured 2140mm side panels. Drawings shown below are with complementary sides)																	
Larder Unit 2 Doors				Larder Unit with Kesseböhmer Pull Out		Larder Unit with Kesseböhmer Tandem Pull Out		Larder Unit with Kesseböhmer Tandem Solo									
	300mm	500mm	600mm		300mm		600mm		500mm	600mm							
	L3W	L3S	L5W		L5S		L6W		L6S	LP3W	LP3	LP6TW	LP6TS	LP6TSW	LP6TSS		
	Price	Price	Price		Price		Price		Price	Price	Price	Price	Price	Price	Price		
PG1	£544	£615	£630	£701	£652	£723	PG1	£1,173	£1,244	PG1	£1,634	£1,705	PG1	£1,402	£1,473	£1,469	£1,540
PG2	£548	£619	£635	£706	£658	£729	PG2	£1,177	£1,248	PG2	£1,640	£1,711	PG2	£1,407	£1,478	£1,475	£1,546
PG3	£596	£648	£724	£776	£764	£816	PG3	£1,225	£1,277	PG3	£1,746	£1,798	PG3	£1,496	£1,548	£1,581	£1,633

Larder Units (Available with White MFC 1967mm sides only)										
1000mm Larder 4 Doors		1000mm Larder 3 Drawers			1000mm Blind Corner Larder			1000mm Blind Corner Larder with Le Mans LH/RH (LH Shown)		
	1245mm x 2 715mm x 2		1245mm x 2 140mm dwr x 1 283mm dwr x 2		500mm door	600mm door		500mm door	600mm door	
	LPN14DW		LPN12D3DW		LBC15W	LBC16W		LBC15LW/RW	LBC16LW/RW	
	Price		Price		Price	Price		Price	Price	
PG1	£1,041	PG1	£1,241	PG1	£911	£932	PG1	£2,434	£2,557	
PG2	£1,051	PG2	£1,253	PG2	£923	£945	PG2	£2,446	£2,570	
PG3	£1,229	PG3	£1,427	PG3	£1,005	£1,044	PG3	£2,528	£2,669	

Extra Tall Larders (Available with White MFC 2148mm sides only)										
Larder Unit 2 Doors			Larder Unit with Kesseböhmer Pull Out		Larder Unit with Kesseböhmer Tandem Pull Out		Larder Unit 2 Doors			
	300mm	500mm	600mm		300mm		600mm		500mm	600mm
	TL3W	TL5W	TL6W		TLP3W		TLP6TW		TLP5TSW	TLP6TSW
	Price	Price	Price		Price		Price		Price	
PG1	£574	£662	£688	PG1	£1,203	PG1	£1,670	PG1	£1,434	£1,505
PG2	£578	£665	£693	PG2	£1,207	PG2	£1,675	PG2	£1,437	£1,510
PG3	£626	£754	£805	PG3	£1,255	PG3	£1,787	PG3	£1,526	£1,622

Panels							Accessories		
Price Groups	Vallo Feature J Pull End Panel			Vallo Filler Panel	Large Universal Panel Breakfast Bar Back Panel		Plinth	Universal Cornice / Pelmet	Edging Tape
	Wall 715 x 385mm	Base 893 x 625mm	Island 893 x 882mm	2200 x 170mm	2200 x 900mm		2400 x 150mm	2400mm	10m
	FEP73	FEP86	FEP88	UP	LUP		PL	BLPEL	ET
PG1	N/A	N/A	N/A	N/A	£188		£55	£51	£12
PG2	N/A	N/A	N/A	N/A	£219		£62	£58	£12
PG3	£198	£266	£322	£55	£188		£55	£51	N/A

Integrated Appliance Doors						Panels				
Price Groups	Integrated Extractor Door	Built Under Fridge / DW / Washer Door	Integrated Slimline Dishwasher Door	Semi-Integrated Dishwasher Door	Boiler Door	Wall Replacement End Panel	Wall Plant On End Panel	Tall Plant On Panel	Base Replacement End Panel	End Support Panel
	450 x 600mm	715 x 600mm	715 x 450mm	570 x 600mm	895 x 600mm	720 x 330mm	900 x 600mm	2200 x 630mm	890 x 570mm	900 x 600mm
	AD60ICH	AD60FD	AD45I	AD60S	BLD9	WREP72	PWEP9	PTEP	REP9L/R	ESP
PG1	£39	£57	£49	£51	£95	£40	£62	£152	£90	£62
PG2	£41	£60	£51	£52	£97	£49	£65	£160	£95	£65
PG3	£67	£97	£77	£79	£140	£40	£62	£152	£90	£62

Please see our brochure for handle images

Code	Description	Centres (mm)	Price
H941	Chrome D-Handle	160/192	£18
H947	Chrome D-Handle	160/192	£19
H1003	Chrome Front-Fix Puro Handle	196	£16
H1007	Chrome Rear-Fix Puro Handle		£20
H146	Satin Nickel D-Handle	160	£13
H931	Satin Nickel D-Handle	160	£18
H918	Satin Nickel D-Handle	128	£11
H933	Satin Nickel D-Handle	160	£13
H932	Satin Nickel Strap Handle	192	£11
H003	Satin Nickel D-Handle	128	£12
H917	S/Steel Bar Handle	160	£13
H264	S/Steel Arch End Handle	160	£14
H1015	Curved End Handle Copper	192	£1
H1011	Curved End Handle B/Nickel	192	£18
H1013	Curved End Handle Chrome	192	£18

Code	Description	Centres (mm)	Price
H1032	Curved End Satin Brass	192	£24
H1033	Slim D-Handle Satin Brass	160	£18
H820	Steel Collar Handle	128	£14
H318	S/Steel Bar Handle	177	£16
H222	S/Steel Bar Handle	160	£13
H1038	Flared D-Handle Chocolate	160	£24
H1039	Flared D-Handle Graphite	160	£24
H1040	Flared D-Handle Copper	160	£24
H150	Chrome Cup Handle	76	£13
H149	Chrome Knob		£13
H962	Copper Angular Handle	160	£25
H942	Antique Effect D-Handle	96	£11
H1043	Round Knob Satin Brass		£16
H1044	Cup Handle Satin Brass	64	£19
H943	Antique Effect Cup Handle	64	£11

Code	Description	Centres (mm)	Price
H1009	Round Knob Pewter		£11
H363	Pewter Effect D-Handle	128	£13
H504	Antique Bronze Strap Handle	96	£13
H1018	S/Steel D-Handle	160	£30
H1019	Black Chrome D-Handle	160	£28
H1020	Chrome Cup Handle	64	£24
H1028	Black Satin Square Knob		£20
H1026	Black Satin Round Knob		£19
H1027	Chrome Square Knob		£19
H1025	Chrome Round Knob		£19
H1024	Black Satin Cup Handle	64	£13
H1030	Antique Bronze Cup Handle	64	£19
H1022	Chrome Cup Handle	64	£13
H1031	Antique Bronze Knob		£19

TECHNICAL SPECIFICATIONS

END ELEVATIONS - CHECK APPLIANCE/LARDER HEIGHT PRIOR TO SETTING WALL UNIT HEIGHT

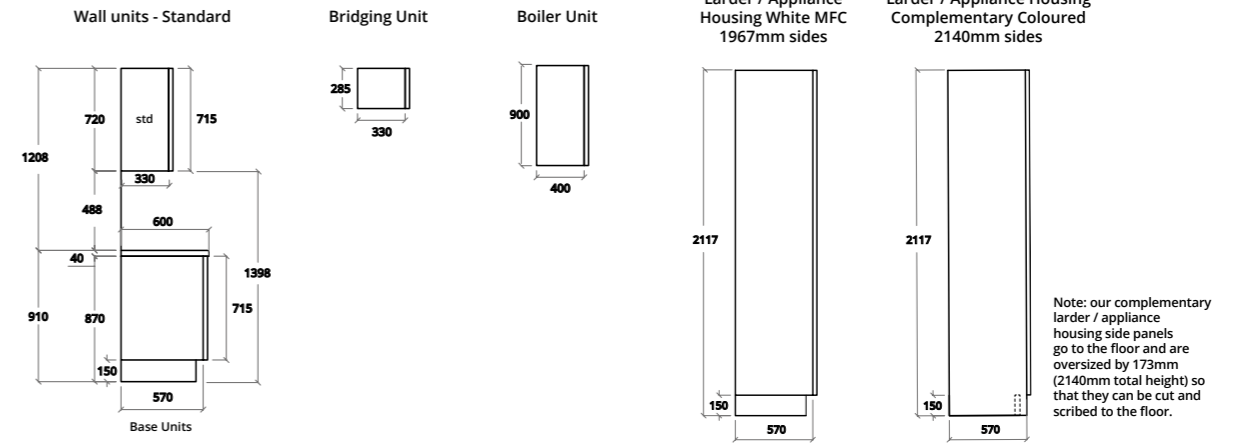

Note: our complementary larder / appliance housing side panels go to the floor and are oversized by 173mm (2140mm total height) so that they can be cut and scribed to the floor.

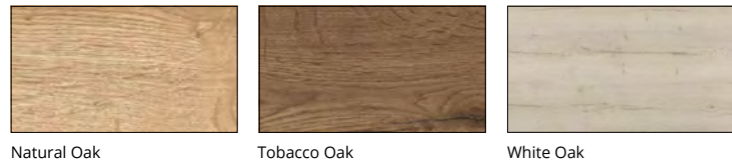

Solutions Panels	Price
End Support / Plant on Base Panel 900 x 600 x 18mm	£77
Large Universal Panel 2400 x 900 x 18mm	£235
22mm Edging for 18mm Panels - 10m	£28

APPLIANCE HOUSING / LARDER / FRIDGE FREEZER (FF) CONFIGURATIONS

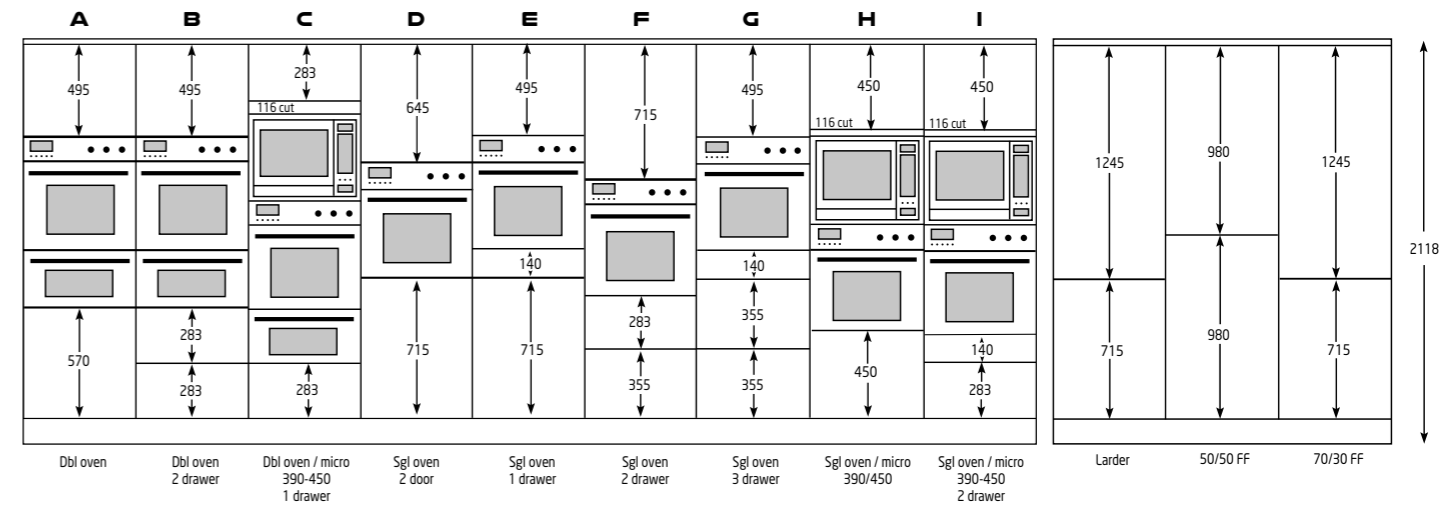

TECHNICAL SPECIFICATIONS

CORNER INFORMATION

800MM CONVENTIONAL CORNER BASE UNIT

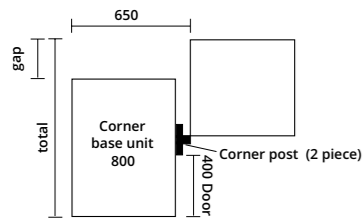

If using alternative door sizes the gap to the wall changes and centre post of cabinet would require refixing.
 300mm door = 150mm gap (950mm total)
 400mm door = 250mm gap (1050mm total)
 450mm door = 300mm gap (1100mm total)

900MM CONVENTIONAL CORNER BASE UNIT

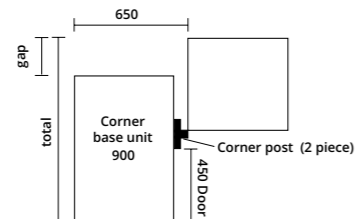

If using alternative door sizes the gap to the wall changes and centre post of cabinet would require refixing.
 450mm door = 200mm gap (1100mm total)

1000MM CONVENTIONAL CORNER BASE UNIT

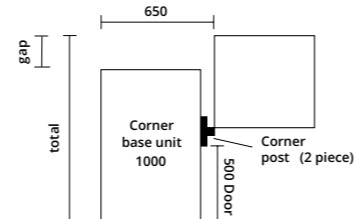

If using alternative door sizes the gap to the wall changes and centre post of cabinet would require refixing.
 500mm door = 150mm gap (1150mm total)
 600mm door = 250mm gap (1250mm total)

1000 BLIND CORNER LARDER TO BASE UNIT

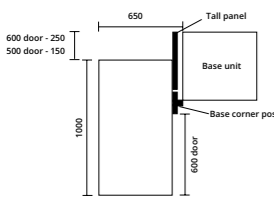

1000MM BLIND CORNER LARDER TO TALL UNIT

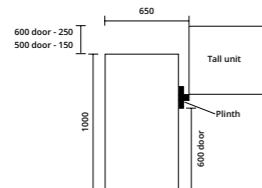

600/900MM CONVENTIONAL CORNER WALL UNIT

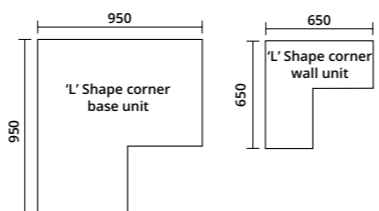
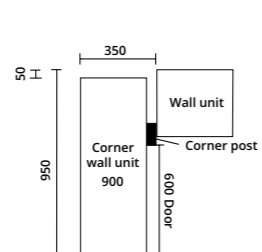

'L' Shape Corner Units Note:- Walls must be square to accommodate L shaped units.

EXTRA TALL APPLIANCE HOUSING / LARDER / FRIDGE FREEZER (FF) CONFIGURATIONS

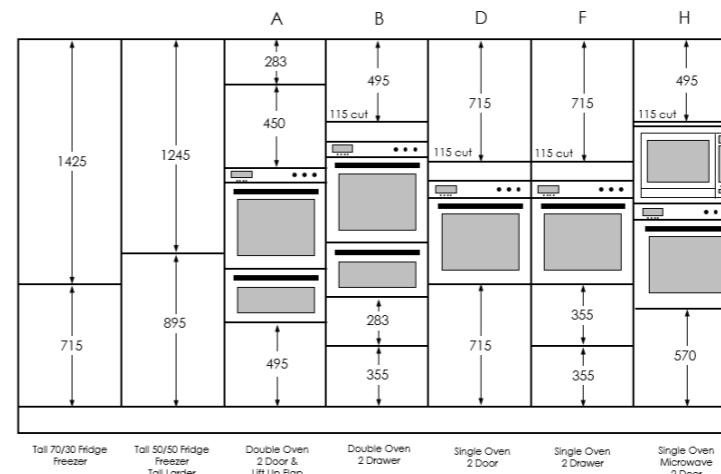

VEW Lighting is available for delivery with your LochAnna or FORM kitchen. With a mix of task and accent lighting, our range has something to suit every kitchen style. These prices are only available when bought with a kitchen - we do not sell these products on their own.



Scan the QR code to find out more from tlwglobal.com

symbols to **COB** = features COB technology **D** = dimmable
K = comes with Konnex system **S** = compatible with a sensor
 look out for:

LED Colours

When ordering your lights, replace the * in the code with either WW or NW based on your preferred LED colour

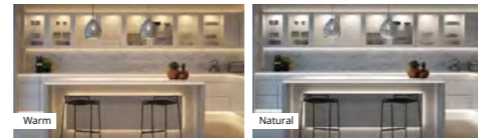

LED Colours

When ordering your lights, replace the * in the code with either WW or NW based on your preferred LED colour

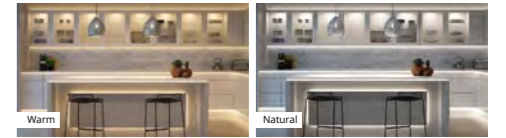

symbols to **COB** = features COB technology **D** = dimmable
K = comes with Konnex system **S** = compatible with a sensor
 look out for:

Our tape lighting and profiles create a contemporary long ribbon of lighting under and over cabinets. Our Surface and Recessed profiles have the advantage of diffusing the light perfectly, with no diodes showing through.

Drivers must be ordered separately. Required driver for each length is shown in the table below.

LED Cabinet Lighting Light	Image	Features	Item	Code	RRP (inc VAT)
1. Nova Mini LED Ultra-Thin Cabinet Light 2.2w Aluminium Construction WW = 140 Lumens NW = 150 Lumens		Dimensions: L150 x W35 x H7mm Surface mounted 2m lead and micro connector	Single Light 3 Light Kit with 8W Driver 5 Light Kit with 15W Driver	K01-0171* K01-0171*-3 K01-0171*-5	£21 £78 £126
2. Galaxy COB LED Tri-Light (IP44) 2.6w Stainless Steel WW = 182 Lumens NW = 192 Lumens		Dimensions: L142 x W126 x H41mm Recess or surface mounted 2m lead and micro connector	Single Light 3 Light Kit with 8W Driver 5 Light Kit with 15W Driver	K01-0120SS* K01-0120SS*-3 K01-0120SS*-5	£19 £72 £116
3. Galaxy COB LED Round Light (IP44) 2.6w Stainless Steel WW = 182 Lumens NW = 192 Lumens		Dimensions: 65mm Diameter Recess or surface mounted (spacer included) 2m lead and micro connector	Single Light 3 Light Kit with 8W Driver 5 Light Kit with 15W Driver	K01-0102SS* K01-0102SS*-3 K01-0102SS*-5	£17 £66 £106
4. Slim Square Panel Light 3w Silver Finish WW = 140 Lumens NW = 150 Lumens		Dimensions: L100 x W100 x H5mm Surface mounted with 3M VHB adhesive pads 2m lead and micro connector	Single Light 3 Light Kit with 15W Driver 5 Light Kit with 15W Driver	K01-0190* K01-0190*-3 K01-0190*-5	£22 £87 £131
5. Slim Rectangular Panel Light 6w Silver Finish WW = 280 Lumens NW = 300 Lumens		Dimensions: L200 x W100 x H5mm Surface mounted with 3M VHB adhesive pads 2m lead and micro connector	Single Light 3 Light Kit with 30W Driver 5 Light Kit with 30W Driver	K01-0191* K01-0191*-3 K01-0191*-5	£27 £114 £168
2m Extension Lead		Can be linked together		R90-0131	£5

The table below shows which 12V driver is required for the lights above

PRODUCT NO	1 LIGHT	2 LIGHTS	3 LIGHTS	4 LIGHTS	5 LIGHTS	6 LIGHTS
1: (2.2w)	8w	8w	8w	15w	15w	15w
2: (2.6w)	8w	8w	8w	15w	15w	30w
3: (2.6w)	8w	8w	8w	15w	15w	30w
4: (3w)	8w	8w	15w	15w	15w	30w
5: (6w)	8w	15w	30w	30w	30w	50w

Driver ports:
8W = 4 ports
15W = 6 ports
30W = 6 ports
50W = 6 ports





Plinth Lighting Light	Image	Features	Item	Code	RRP (inc VAT)
Sola Round IP65 LED Plinth Light 0.4w Polished Chrome WW = 27 Lumens NW = 27 Lumens		Dimensions: 30mm Diameter Recess mounted 3m lead and micro connector	Single Light 4 Light Kit with 8W Driver 8 Light Kit with 8W Driver	K01-0030P* K01-0030K4PC* K01-0030K8PC*	£6 £39 £72
Strata Square IP65 LED Plinth Light 0.18w Stainless Steel WW = 15 Lumens NW = 20 Lumens		Dimensions: L50 x W50 x H9mm Recess mounted 3m lead and micro connector	Single Light 4 Light Kit with 8W Driver 8 Light Kit with 8W Driver	K01-0040* K01-0040K4C* K01-0040K8C*	£7 £43 £72

Drawer Lighting Light	Image	Size	Wattage Lumens	Driver Required	Code	RRP (inc VAT)
Sabre LED Drawer Light with IR Sensor Natural White Satin Silver Finish Driver must be ordered separately		462mm (500mm drawer) 562mm (600mm drawer) 762mm (800mm drawer) 862mm (900mm drawer) 962mm (1000mm drawer)	4.5w 169 Lumens 5.5w 207 Lumens 7.5w 280 Lumens 8.5w 335 Lumens 9.5w 364 Lumens	8w 8w 8w 15w 15w	K01-0200NW-462 K01-0200NW-562 K01-0200NW-762 K01-0200NW-862 K01-0200NW-962	£33 £38 £45 £50 £55

LED Cabinet Lighting Light	Image	Features	Size	Driver Required	Code	RRP (inc VAT)
Dotless IP65 LED Tape 144 LEDs per Metre 10w per m Frontview Tape WW = 650 Lumens/m NW = 700 Lumens/m Self-adhesive with 3M VHB tape		Dimensions: W10 x D10mm Cuttable every 20.8mm 2m lead and micro connector Not compatible with profiles or clip on connectors	1m Length 2m Length 3m Length	15w 30w 30w	K30-1270*-1M K30-1270*-2M K30-1270*-3M	£33 £60 £84
Dotless IP65 LED Tape 144 LEDs per Metre 10w per m Sideview Tape WW = 240 Lumens/m NW = 260 Lumens/m Self-adhesive with 3M VHB tape		Dimensions: W10 x D10mm Cuttable every 20.8mm 2m lead and micro connector Not compatible with profiles or clip on connectors	2m Length 3m Length 5m Length	30w 30w 50w	K30-1260*-2M K30-1260*-3M K30-1260*-5M	£60 £84 £135
Callo LED Tape 60 LEDs per Metre 4.8w per m Great for accent lighting WW = 385 Lumens/m NW = 430 Lumens/m Self-adhesive with 3M VHB tape		Dimensions: W8 x D3mm Cuttable every 50mm 2m lead and micro connector Suitable with any profile	1m Length 2m Length	8w 15w	K30-5720*-1M K30-5720*-2M	£24 £39
Bon LED Tape 120 LEDs per Metre 9.6w per m Great for task lighting WW = 760 Lumens/m NW = 865 Lumens/m Self-adhesive with 3M VHB tape		Dimensions: W8 x D3mm Cuttable every 25mm 2m lead and micro connector Suitable with any profile	1m Length 2m Length	15w 30w	K30-5730*-1M K30-5730*-2M	£15 £31

LED IP65 Callo Tape, Connectors & Leads	Image	Features	Size	Driver Required	Code	RRP (inc VAT)
Callo IP65 LED Tape 60 LEDs per Metre 4.8w per m Great for accent lighting WW = 345 Lumens/m NW = 389 Lumens/m Self-adhesive with 3M VHB tape		Dimensions: W8 x D3mm Cuttable every 50mm 2m lead and micro connector IP65 - protected from dust ingress and low pressure water jets	5m Length	1m = 8w 2-3m = 15w 4-5m = 30w	K30-5725*	£67
LED 8mm Tape 2m Power Connector Use for a piece of tape that's been cut and requires a new power lead		Comes with micro connector			K30-5800IPMP	£5
LED 8mm Tape Link Connector Link two pieces of cut tape, using one power lead		50mm 1000mm 2000mm			K30-5810IP K30-5812IP K30-5813IP	£3 £3 £5
LED 8mm Butt Connector Link two pieces of cut tape					K30-5815IP	£3

LED Tape Profiles Profile	Image	Features	Size	Code	RRP (inc VAT)
Smart Surface Aluminium Profile Kit contains opal diffuser, end caps and fixing clips		No diode effect Dimensions: W12 x H12mm	1m Length 2m Length	K01-1035KIT-1M K01-1035KIT-2M	£21 £33
Smart Recessed Aluminium Profile Kit contains opal diffuser, end caps and fixing clips		No diode effect Dimensions: W18.8 x H12mm	1m Length 2m Length	K01-1037KIT-1M K01-1037KIT-2M	£21 £33
Corner Aluminium Profile Kit contains opal diffuser, end caps and fixing clips		No diode effect Dimensions: W24 x H19.4mm	1m Length 2m Length	K01-1060KIT-1M K01-1060KIT-2M	£29 £50

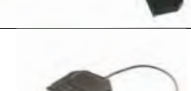

Drivers	Image	Features	Code	RRP (inc VAT)
8w 12V LED Driver 4-Port Micro Plug Connector		Max 8w Rated input voltage: 200-240AC Dimensions: L94.5 X W46.2 X H19.5mm 1m mains cable supplied	K10-1200	£15
15w 12V LED Driver 6-Port Micro Plug Connector		Max 15w Rated input voltage: 200-240AC Dimensions: L103 X W35 X H16mm 1m mains cable supplied	K10-1220	£21
30w 12V LED Driver 6-Port Micro Plug Connector		Max 30w Rated input voltage: 200-240AC Dimensions: L156 X W50 X H17mm 1m mains cable supplied	K10-1230	£33
50w 12V LED Driver 6-Port Micro Plug Connector		Max 50w Rated input voltage: 200-240AC Dimensions: L160 X W58 X H18mm 1m mains cable supplied	K10-1250	£50
Extender Block 4-Port Micro Plug Connector		Increase the number of ports on your LED driver or sensor. Note: the connector block will use one of the existing ports on an LED driver. Can be used on all driver and sensor types.	R90-0133	£5

Pop Up Socket Item	Image	Features	Code	RRP (inc VAT)
Pop Up Socket Power Port & USB Charger Stainless Steel top & silver/black body		3 x 13A Sockets 2 x 2A USB Ports Dimensions: W15 x D18.8mm 1.5m power cable with BS plug 13A rated	N28-0171SS	£94

Sensors & Switches
Sensors & switches are a great way to control your lighting. Look out for how each sensor/switch is activated by looking for our handy symbols.

Symbols to look out for:



Drivers	Image	Features	Code	RRP (inc VAT)
Single Door IR Sensor Switch Detection range: 50-100mm Comes with 4-port connector block	 DA	Recessed or surface mounted (12mm cutout for recessed) Lights turn off when door is in front of sensor Dimensions: W15 x D18.8mm Cable length 1.1m	N28-0001	£21
Double Door IR Sensor Switch Detection range: 50-100mm Comes with 4-port connector block	 DA	Recessed or surface mounted (12mm cutout for recessed) Lights turn off when door is in front of sensor Dimensions: W15 x D18.8mm Cable length 1.1m	N28-0001D	£33
Motion IR Sensor Switch Detection range: 50-100mm Comes with 4-port connector block	 MA	Recessed or surface mounted (12mm cutout for recessed) Wave or move in front of sensor to switch the lights on and off Dimensions: W15 x D18.8mm Cable length 1.1m	N28-0004	£21
Dimmer Touch Sensor Switch Recessed (17mm cutout) Comes with 4-port connector block	 TA	Loading power 12V - 60w Hold finger on sensor to dim lights up or down Dimensions: W20 x D14mm Cable length 1.5m	N28-0005	£15

Remote Control Lighting & Drivers

Smart technology and in particular, smart lighting, is becoming a prominent choice of lighting control for the consumer thanks to the flexibility it offers to match their lifestyle.

Key Features:



- Multi-zone control
- Compatible with single colour LED lighting
- Programmed scenes can be activated at the touch of a button
- Compatible with all VEW lighting products
- Helps to create a lighting design to fit around your lifestyle
- Perfect solution to control the lighting in your smart home







Illustrated examples of zones



To learn more about remote controlled lighting, scan the QR code

How to create remote controlled multi-zone lighting	Choose your driver (to suit the wattage of your lights)	Add a Receiver	Add a Remote Control
	 This must be a UNI driver	 K30-2037	 K30-2034

Item	Image	Features	Code	RRP (inc VAT)
Single Colour LED Dimming Remote Control Up to 30m range		Controls up to 4 zones Up to 3 scenes for each zone Controls up to 8 receivers / drivers per zone	K30-2034Z	£77
Single Channel Remote Receiver Comes with 6-port connector block		Compatible with switch and dimmable single colour LED lights Up to 288w Requires LED driver - 12V input	K30-2037ZU	£48

Compatible Drivers	Image	Features	Code	RRP (inc VAT)
8w 12V LED Driver for Remote Control System Uni Plug (plugs into connector block supplied with receiver)		Max 8w Rated input voltage: 200-240AC Dimensions: L94.5 X W46.2 X H19.5mm 1m mains cable supplied	K10-1200UNI	£15
15w 12V LED Driver for Remote Control System Uni Plug (plugs into connector block supplied with receiver)		Max 15w Rated input voltage: 200-240AC Dimensions: L103 X W35 X H16mm 1m mains cable supplied	K10-1220UNI	£21
30w 12V LED Driver for Remote Control System Uni Plug (plugs into connector block supplied with receiver)		Max 30w Rated input voltage: 200-240AC Dimensions: L156 X W50 X H17mm 1m mains cable supplied	K10-1230UNI	£33
50w 12V LED Driver for Remote Control System Uni Plug (plugs into connector block supplied with receiver)		Max 50w Rated input voltage: 200-240AC Dimensions: L160 X W58 X H18mm 1m mains cable supplied	K10-1250UNI	£50

Standard Appliance Housings / Larder / Fridge Freezer (FF) Configurations

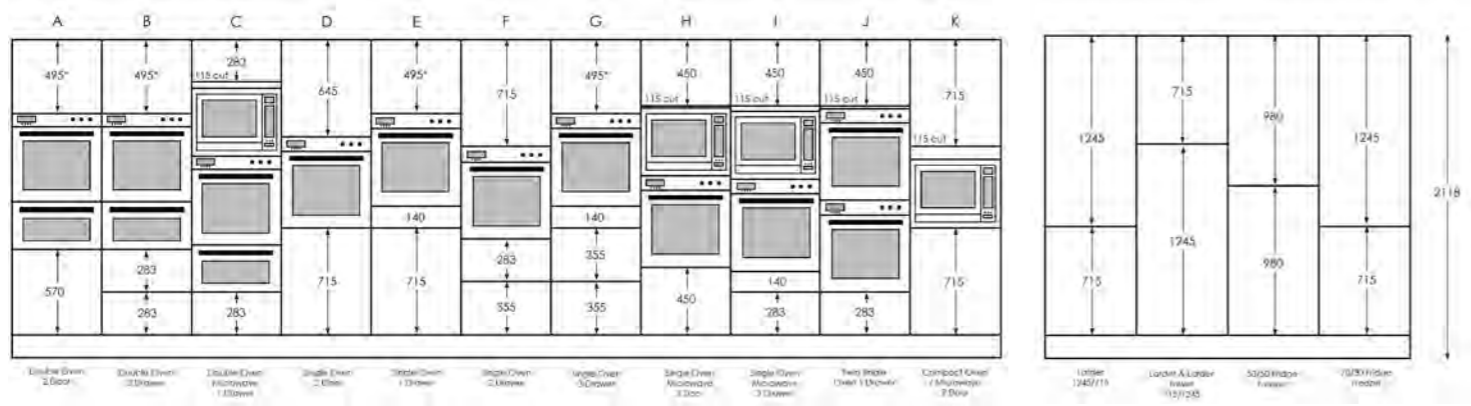

* Please note: Mala Matt doors are 490mm high, not 495mm

Note: our larders can be fitted either 1245/715 or 715/1245. The side panels must be flipped the correct way up so that the fixed shelf holes are in the desired position

Durham Appliance Housings / Larder / Fridge Freezer (FF) Configurations

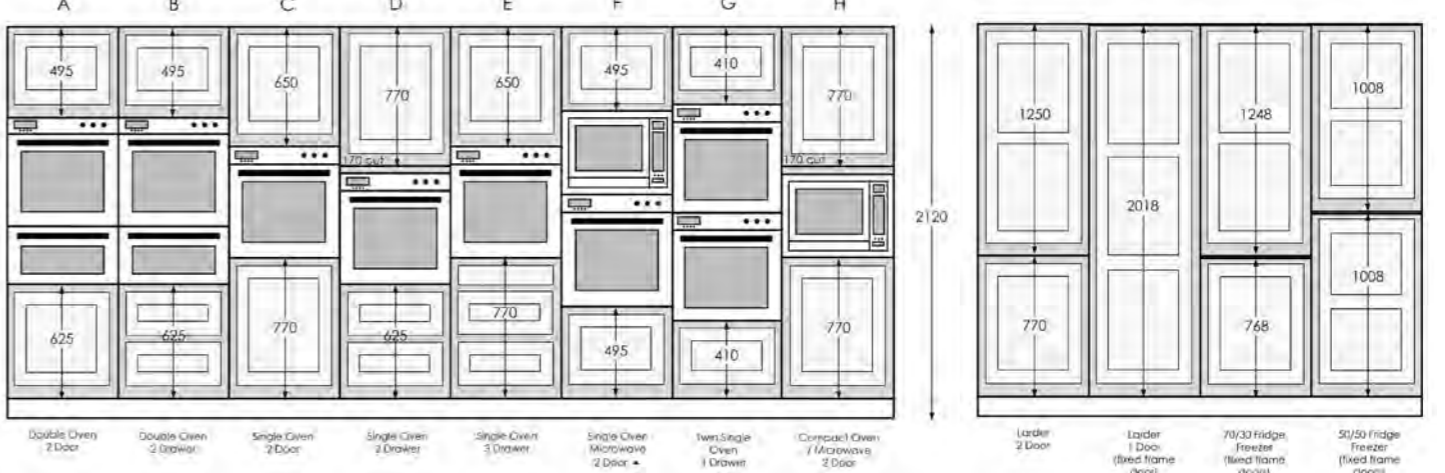

▲ Note: the bottom frame of the top 495mm door will need to be trimmed on site to suit the height of microwave chosen. Note: fixed frame doors have a 35mm top frame instead of 37mm

Tall Appliance Housings / Larder / Fridge Freezer (FF) Configurations

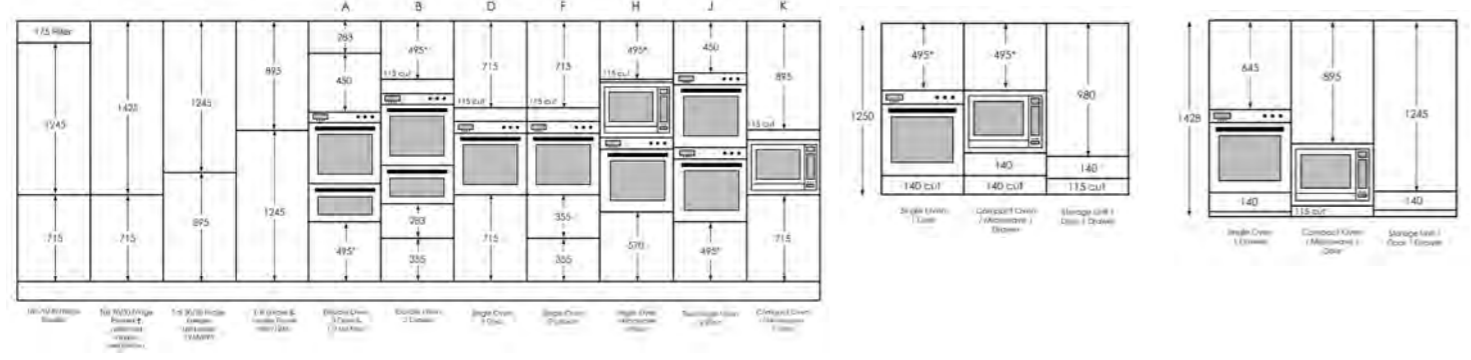

For oven / microwave units you will need to install a filler panel, cut to suit from a 116mm oven fascia

Note: our tall larders can be fitted either 1245/895 or 895/1245. The side panels must be flipped the correct way up so that the fixed shelf holes are in the desired position

† Available in Eterna, Clarkwell, Georgian, Elswick, Rowan, Hutton, Thistleton, Faversham

Durham Tall Appliance Housings / Larder / Fridge Freezer (FF) Configurations

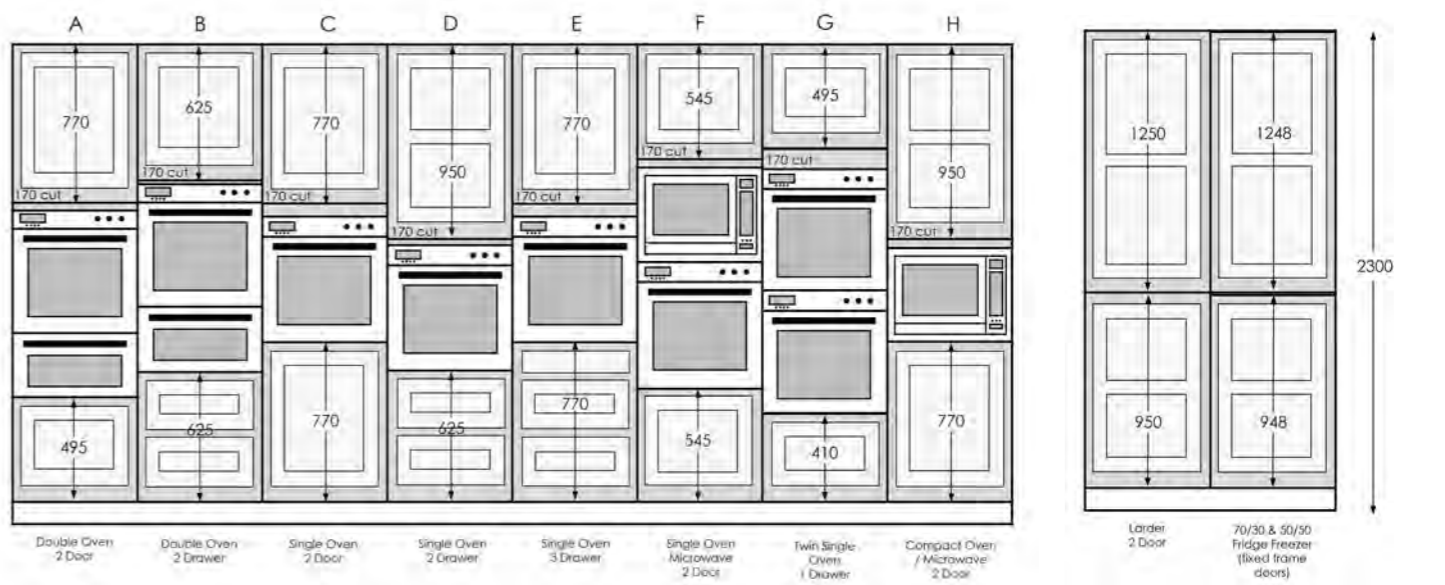

Note: fixed frame doors have a 35mm top frame instead of 37mm

End Elevations - check appliance/larder height prior to setting wall unit height

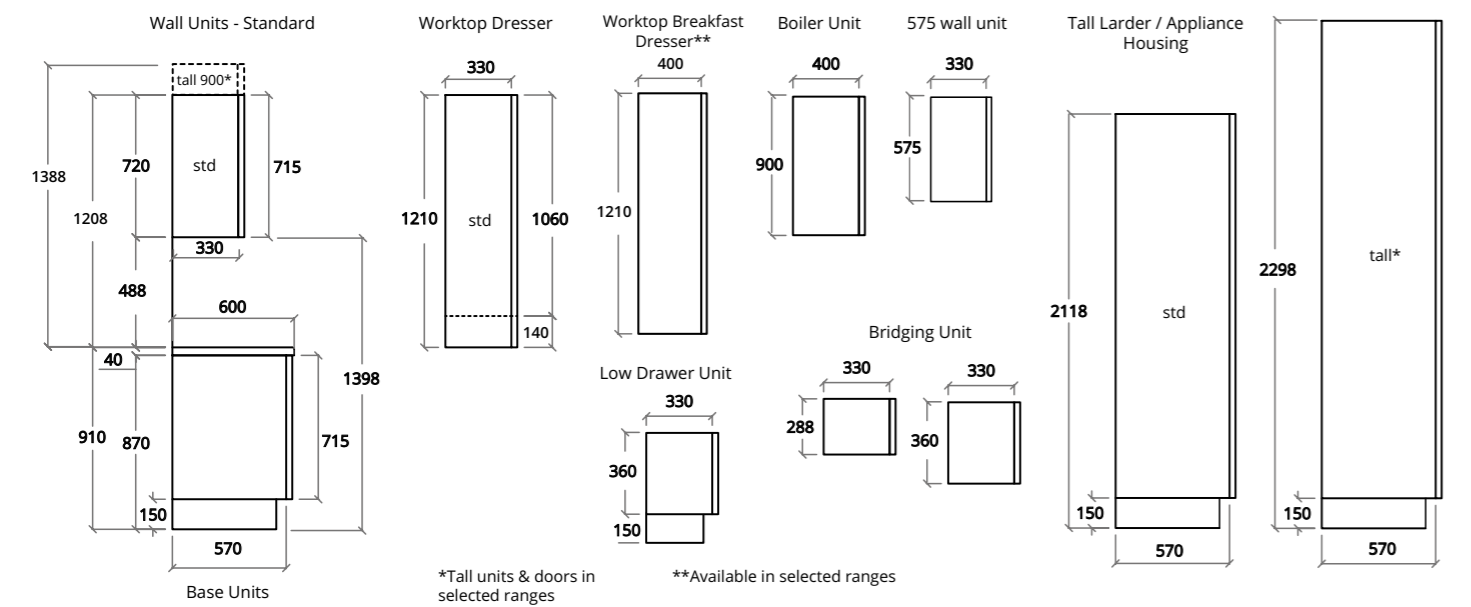

*Tall units & doors in selected ranges
**Available in selected ranges

Durham End Elevations all measurements are shown in millimetres and are nominal sizes

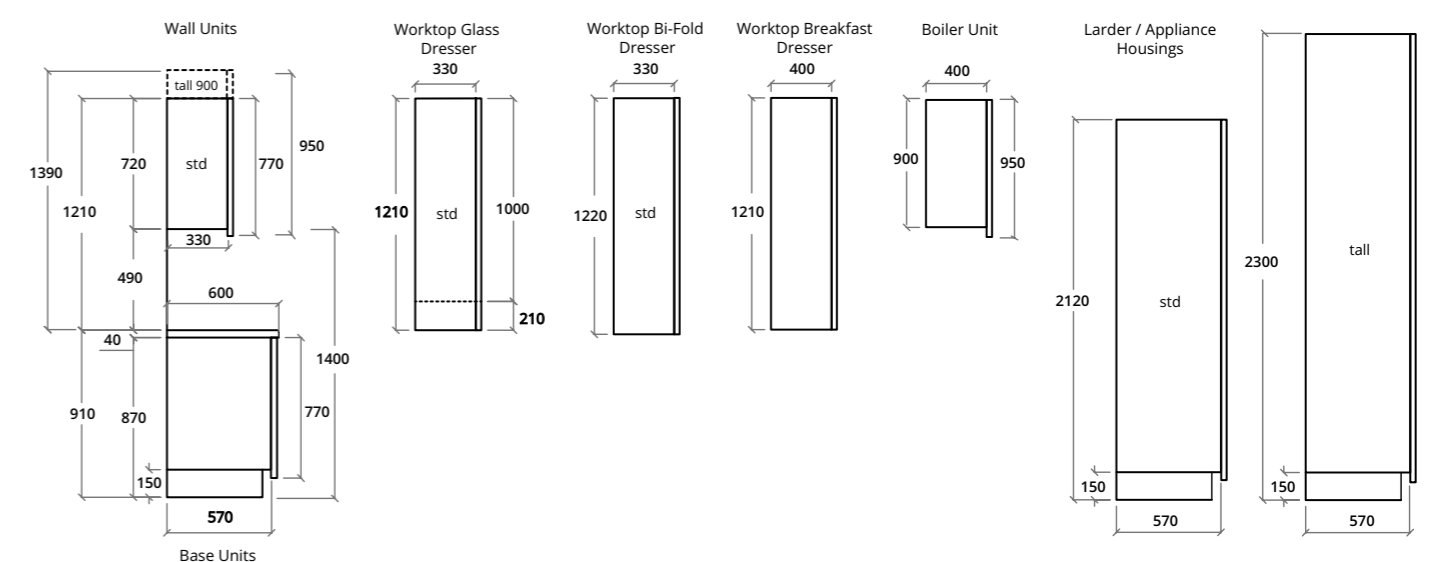

FORM Tall Housings & Larders

FORM offers a choice of appliance housings. Ensure you allow for the vertical rail spacing as you plan. All larder panels are 1970mm high. The internal depth of the appliance housings and larders is 500mm.

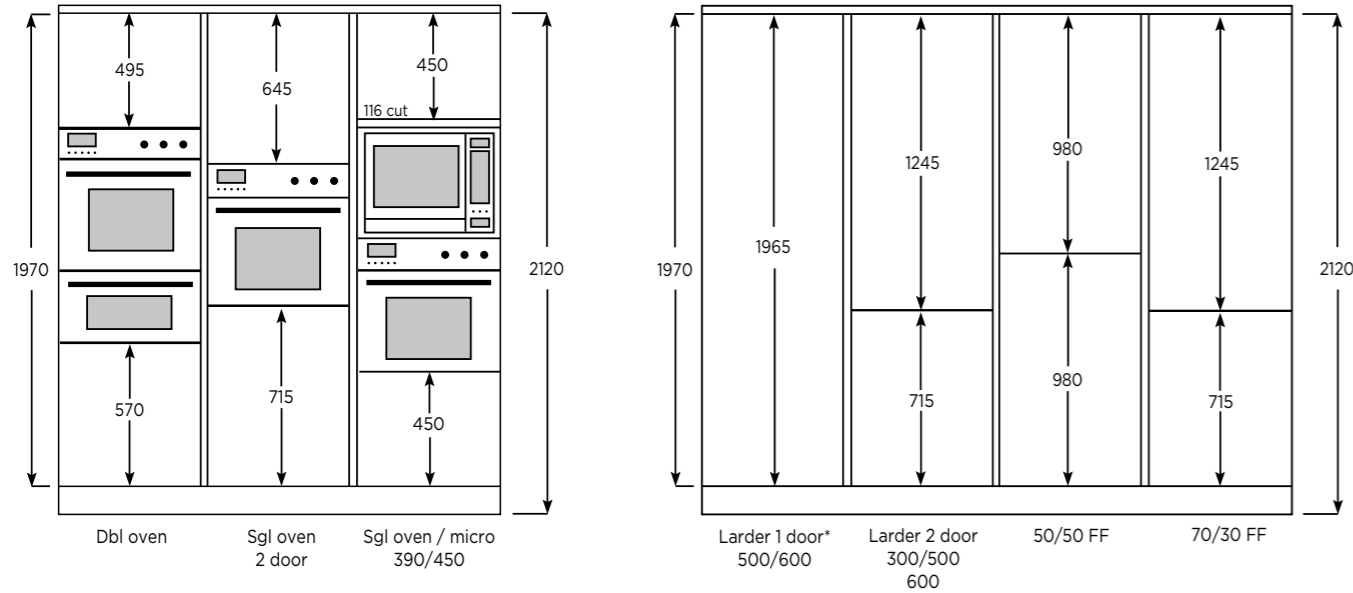

End Elevations - check appliance/larder height prior to setting wall unit height.

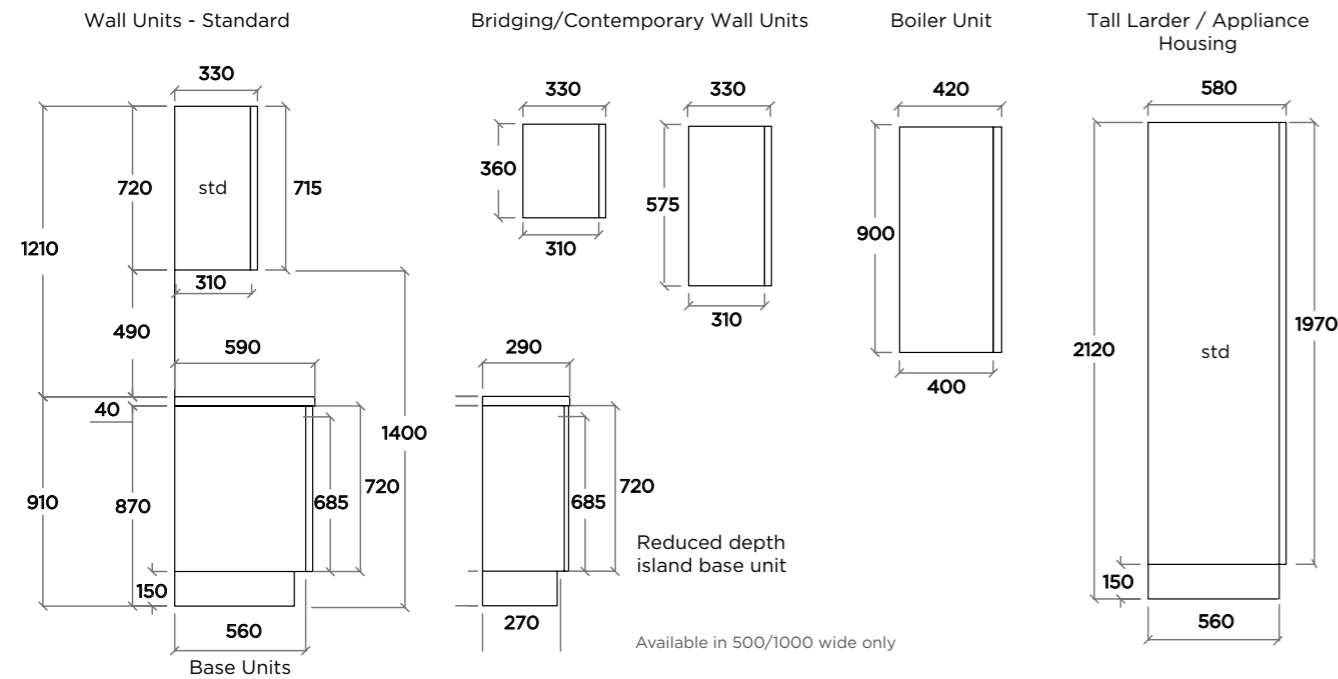

Overall Cabinet Dimensions

With a choice of full height doors, two and three drawer packs, your LochAnna FORM kitchen can be designed to your individual needs and taste.

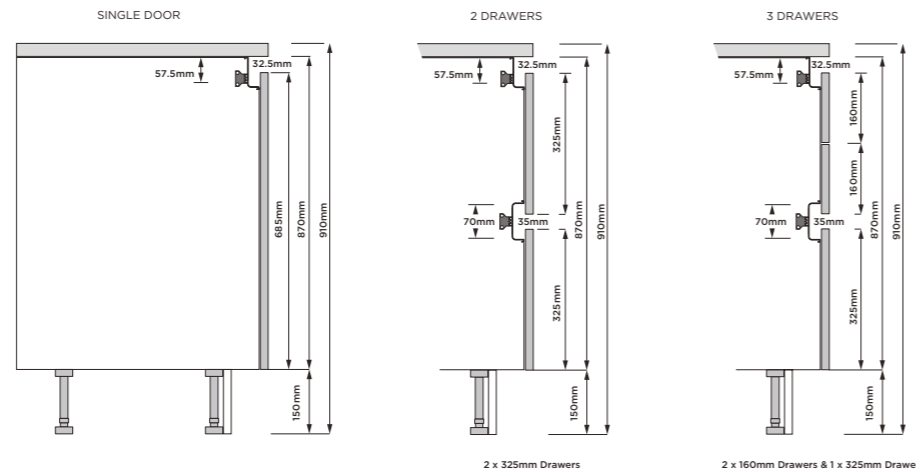

LochAnna Corner Unit Planning

800mm Conventional Corner Base Unit

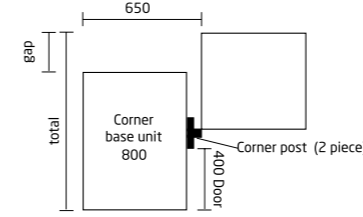

NB: All ranges offer a 2 piece variable corner post with the exception of Profile which offers a fixed post at 80mm or 60mm. For other dimensions cut a 300mm slab door - please specify when ordering.

If using alternative door sizes the gap to the wall changes and centre post of cabinet would require refixing.
300mm door = 150mm gap (950mm total)
400mm door = 250mm gap (1050mm total)
450mm door = 300mm gap (1100mm total)

900mm Conventional Corner Base Unit

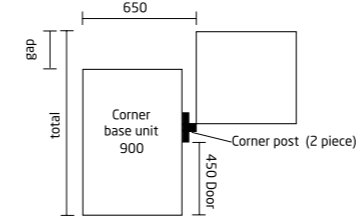

If using alternative door sizes the gap to the wall changes and centre post of cabinet would require refixing.
450mm door = 200mm gap (1100mm total)

1000mm Conventional Corner Base Unit

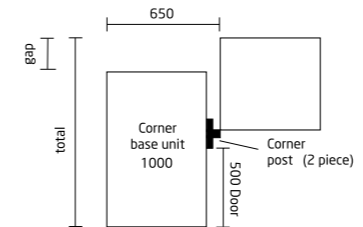

If using alternative door sizes the gap to the wall changes and centre post of cabinet would require refixing.
450mm door = 100mm gap (1100mm total)
500mm door = 150mm gap (1150mm total)
600mm door = 250mm gap (1250mm total)

1016 Diagonal Corner Larder Unit

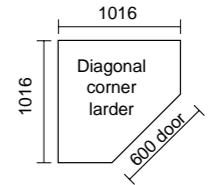

600mm Conventional Corner Wall Unit

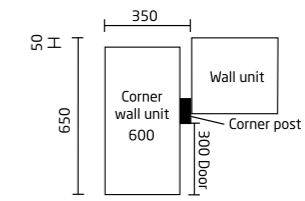

900mm Conventional Corner Wall Unit

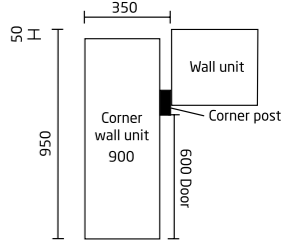

'L' Shape Corner Units

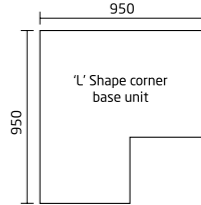
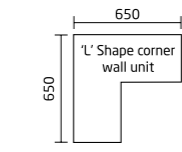

Note:- Walls must be square to accommodate L shaped units.

NB: Profile range uses 60/80mm fixed J pull posts.

1000 Blind Corner Larder to Base or Tall Unit

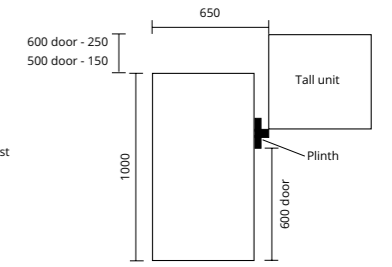
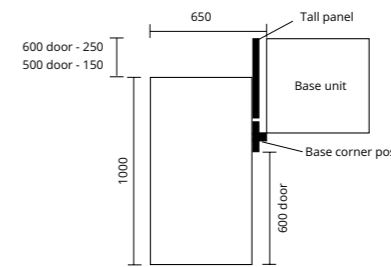

When installing a 1000 blind corner larder adjoining (90 degrees to) a base unit please order a tall plant on panel to blank off/fill the space between the opening door and wall. You will also need to order or fabricate a base corner post for under the worktop. When installing a 1000 blind corner larder adjoining (90 degrees to) another tall/larder unit a plinth will be included to make a suitable corner post.

FORM Corner Unit Planning

800mm Conventional Corner Base Unit

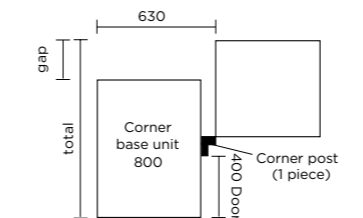

If using alternative door sizes the gap to the wall changes and centre post of cabinet would require refixing.

300mm door = 130mm gap (930mm total)
400mm door = 230mm gap (1030mm total)
450mm door = 280mm gap (1080mm total)

900mm Conventional Corner Base Unit

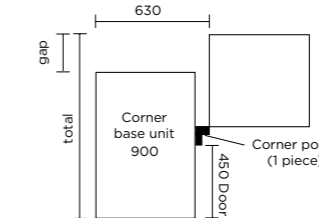

If using alternative door sizes the gap to the wall changes and centre post of cabinet would require refixing.

450mm door = 180mm gap (1080mm total)

1000mm Conventional Corner Base Unit

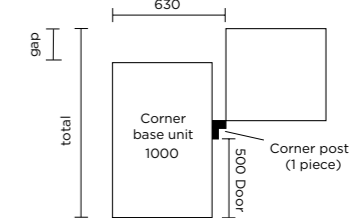

If using alternative door sizes the gap to the wall changes and centre post of cabinet would require refixing.

450mm door = 80mm gap (1080mm total)
500mm door = 130mm gap (1130mm total)
600mm door = 230mm gap (1230mm total)

600mm Conventional Corner Wall Unit

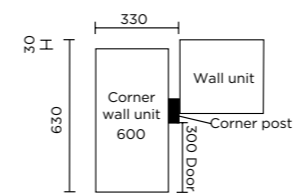

900mm Conventional Corner Wall Unit

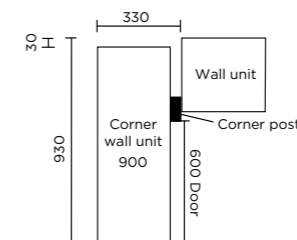

NB: FORM uses a 715 x 147mm door as corner post

NB2: Conventional corner wall units include a separate mullion kit, complete with fixings and pre drilled for hinges

General Care & Maintenance

Door Material Information

Painted & Stained Ranges

LochAnna offers a selection of paints and stains for a variety of our door styles. Painted and stained doors are manufactured using high quality hardwoods or MDF Plus to which a superior quality paint or stain is then applied.

All of our high-quality hardwoods are kiln dried to a moisture content of 6-10%. However, timber, by nature, is susceptible to expansion and shrinkage depending on the environment in which it is installed. This means it could expand when there is an abundance of moisture in the air, particularly in winter or when excess moisture is prevalent in renovated or new builds. Contraction may occur in the summer months when the climate is drier. This potential natural movement of the timber can cause any layer of paint, lacquer, varnish etc. that has been applied, to move with it and may result in panel shrinkage and hairline cracks along the joints of the door. This is considered to be a positive feature, adding an authentic look and feel to the kitchen of any customer who appreciates the fine, natural qualities of timber. This must be explained to the customer upon sale of the product. For customers who would prefer not to live with the natural characteristics of timber, a foil door or MFC would be the ideal choice. Unlike timber, it remains static and is available in a range of colours and styles. Please note: In the event of hairline cracks appearing on doors with a painted finish, LochAnna cannot be held liable.

MDF painted ranges are manufactured from MDF that provides a stable material that can be finished to an exceptionally high standard. It has more compact fibres within the core to provide a smoother finish when routed. We use a pre-tensioned MDF Plus to provide resistance to bowing. The smooth painted product is sustainable to whatever humidity conditions it is fitted in. It will not crack at the joints, the paint will not fracture on the door and the doors will not twist or warp. Ultimately the products will remain stable within the kitchen for a long period of time.

Gloss Painted Ranges

Certified by CATAS, all our gloss painted ranges will withstand the daily rigours of human activity without ever looking worn or tired. We would go as far as to say our gloss kitchens are all your customers will ever need.

Profile Gloss is a slab door with integrated handle and an over-painted 22mm MDF core and gloss polyurethane finish.

Mala Gloss is an overpainted 18mm MDF core slab door with a high gloss polyurethane finish.

Timber Ranges

As with all LochAnna products you can be sure that our timber ranges meet the highest standards expected by our retailers and their customers. Our timber doors and accessories are sourced from the finest suppliers all over the world and due to their sophisticated design and superior workmanship not only look beautiful, but can also be expected to remain looking beautiful throughout their lifetime. Offered in a large number of styles and finishes, our timber ranges can be relied on to please even the most discerning customer.

Sourcing: In the production and sourcing of solid wood and veneered products, great care is exercised in the selection and quality of suitable materials. Every effort has been made to source FSC certified product.

Grain: Solid timber is a natural living product, it is not possible nor desirable to strive for total uniformity of shading and grain pattern. Our aim is, at all times, to operate within controlled parameters that recognise variations as both acceptable and aesthetically pleasing. Before installation, it is advisable that you place your frontals in a suitable arrangement in order to achieve a consistent look.

Curved mouldings: Curved mouldings are crafted from solid timber only, unlike straight mouldings which are veneered. The process of creating curved mouldings requires a build up of several pieces of timber being laminated together and then shaped accordingly. The nature of this process, coupled with the curved shape, will result in a proportion of end grain showing. This curved end section will always be comparatively darker in colour than straight sections (just as the top of a door where rail meets stile shows end grain that is always darker in colour).

Light affecting colour: Wood changes colour when exposed to light. Species of the timber and the intensity of exposure will affect the rate of change. It is advised that colour change is taken into consideration when replacing or fitting new doors some time after the original kitchen has been installed.

Moisture: Timber is hygroscopic meaning it absorbs and releases water depending on its surrounding environment. Due to this being out of our control we recommend all timbers are stored and installed in areas that have been properly acclimatised over a period of time.

Installation Advice

With the appropriate care and maintenance our kitchen doors and components are designed to provide many years of reliable service. To help keep it in the best possible condition please follow the simple guidelines below.

Pre-installation:

Ensure that all new-builds or newly plastered rooms have been left to environmentally stabilise prior to the installation of new kitchen doors. Kitchen doors must not be installed into a damp or moisture-rich environment as it will cause undesirable movement in the joints and panels of the door. A hygrometer should be used to assess conditions.

To help to minimise any potential damage to the kitchen whilst you are installing it, please read and adhere to the following instructions and recommendations:

We would advise that you make an initial check to confirm that you have the correct quantity and sizes of fascias; you can do this by referring to the labels attached to the outer packaging.

Take extreme care when unpacking the fascias and do not use sharp blades to cut away the packaging. The fascias should be stored flat and away from the working area. Take extreme care when stacking the fascias with hinges attached to ensure that the hinges do not mark other fascias. Do not lean the fascias against one another, or against any surface without proper protection in-between.

When attaching the hinges, place the fascia face down on a soft clean surface, ensuring that there is no grit, sawdust or other matter underneath than can damage the surface of the fascia whilst the hinges are attached. It is good practice to place a sheet of clean cardboard between the fascia and the flat surface prior to attaching the hinges. Once the hinges have been attached to a door, hang the door on the unit straight away to avoid damage. Do not stack the doors with the hinges touching other doors, as this can cause scratches or marks to the other fascias.

Do not stack the doors on their ends on any hard surface; this can cause chipping and scratching along the edge of the fascia, especially on the handle edge of ranges with an integral handle. Prior to fitting, the fascias should be stored flat, ensuring that they are not resting on any dirt or debris that may damage or mark the finish.

Take extreme care not to put the door down on any hard or rough surface such as bare concrete floors, or on any debris such as sawdust, grit or screws, as this can damage the product.

Where cutting/scribing décor panels and trim, you must use a sharp quality saw blade of the appropriate grade for fine-cutting, or a suitable router. Small chips can appear along the cut-edge, and so extra care must be taken to minimise the risk of chipping. Using a blunt or inappropriate saw blade will produce a poor finish, and this will not be covered by the guarantee.

On painted products – any fine chips along the cut edge should be smoothed with a fine grade sand paper prior to fitting. All cut edges should be sealed against moisture ingress using a suitable water resistant sealant/adhesive prior to installation. All trims are supplied in long lengths and need to be cut down on site, and again it is important that this is done using the appropriate tools. When fitting the plinth, ensure that you check the dimensions of any adjacent appliances. On occasion, the plinth may need to be pulled forward to ensure that it clears the front of the appliance. This can be achieved by fitting blocks using off-cuts to the rear of the plinth prior to attaching the plinth clips, to step the plinth forward from its normal position.

General Care

As with all kitchen furniture, the most common problems found occur as a result of excessive or prolonged exposure to heat and/or moisture. Always ensure that water is not left around sink areas as damage caused as a result is not covered by the guarantee. Always wipe off excess moisture and be careful with extreme heat sources, such as kettles, ovens and toasters. It is recommended that these heat sources are not placed directly under wall units when they are in use; they generate a higher level of heat and moisture than is often appreciated and can quickly and easily lead to damage of the furniture.

If using glass cleaner to clean your glass doors be careful not to damage the finish of the door and cabinet parts while cleaning. Do not spray glass cleaner directly on to the glass or cabinet parts as this may discolour the finish of your kitchen cabinets.

Don't open the door of the dishwasher immediately after the programme has ended, as exposure to heat and the high humidity increases the risk that the door may absorb moisture and swell.

Please note that after a period of time it is quite normal for the colouring of kitchen units to mellow in colour. This is not a manufacturing fault and is as a result of exposure to light. This means that any additional parts subsequently ordered for your kitchen, or supplied as replacements, may not be an exact colour match. However any additional parts supplied will also mellow over time to blend with your existing units. The colour of doors and drawer fronts may appear mismatched in colour. This apparent mismatch is sometimes the effect of differing light conditions within your kitchen, (known as metamerism).

Cleaning advice for all door types:

Do not use wax furniture polish, abrasive or aggressive cleaners, bleach or other hypochlorite (chlorine) based cleaners, multipurpose cleaners, dilutes, acetone, alcohol, solvent or similar products on the door, as this will damage the surface. Additionally, wax and polishes leave a residue build up that is difficult to remove. Only use a 5% soap, 95% water (liquid soap) solution, wiping with a damp (not wet) cloth, finally drying with a soft, clean cloth only. Ensure all cooking splashes are wiped immediately with a damp cloth and dust with a soft cloth only. Never use any abrasive pads or abrasive cleaners on the furniture. Spills and condensation on the fascias/panels should be cleaned and dried immediately.

Timber & Veneered Doors

Cleaning: when cleaning timber doors you must follow the pattern of the grain. It is advisable to use a damp (not wet) cloth to remove fingerprints and marks, followed at once with a clean and dry soft cloth.

Moisture: excess moisture can damage a timber product – it is recommended that susceptible areas such as around the sink are thoroughly maintained and kept dry at all times.

Light: timber changes colour when exposed to light. Light, lacquered surfaces also have a certain tendency to “yellow with age” depending on the exposure to light. The species of timber and intensity of exposure will affect the rate of change. Due to this we recommend that timber samples be changed regularly.

It is advised that colour change is taken into consideration when replacing or fitting new doors some time after the original kitchen has been installed.

Foil Doors

Moisture: Please be careful not to puncture the foil/melamine lacquered surface of your panels. These should be kept dry in order to prevent moisture ingress.

Cleaning: Periodically clean the interior and exterior surfaces of the door using a soft, damp cloth. Wipe dry all surfaces after cleaning. Use only cleaning agents that are intended for the materials used in your kitchen. There are a number of products available which are designed for cleaning foil doors, but plain water is also good for regular cleans. Always use a lint free soft cloth and use a circular motion to achieve a high buff. Micro-fibre cloths are also perfect for achieving a smear-free finish with very little effort. Avoid any agents that contain ammonia, alcohol, bleach or an abrasive. If the surface of the product is exposed to any oil based substance (for example olive oil, butter, margarine or cooking oil), the spillage must be wiped away immediately to prevent staining. Foil doors do sometimes show fingerprints – but this is easily taken care of with a soft cloth. Grease marks caused by these oil-based products can easily be removed by use of a mild detergent, non-abrasive cleaner if used immediately after spillage has happened. Abrasive cleaners are not recommended for this type of product.

Do not expose the doors or panels to temperature in excess of 60°C (140°F) (Approximately the temperature of washing up water).

Light: If the doors are supplied with a protective film on the face they must not be directly exposed to sunlight. Once installation is complete, carefully remove the protective film from the front of the fascia. We also advise that colour change is taken into consideration when replacing or fitting new doors some time after the original kitchen has been installed.

Painted Doors

Cleaning: it is advisable to use a damp (not wet) cloth to remove fingerprints and marks, followed at once with a clean and dry soft cloth. Any form of furniture polish or other cleaning products should be avoided.

Stained Doors

The LochAnna range of stains are protected by an application of lacquer.

Cleaning: it is advisable to use a damp (not wet) cloth to remove fingerprints and marks, followed at once with a clean and dry soft cloth.



LochAnna